

PROCESSGEO

User Guide

GeoDict release 2023

Published: May 31, 2023

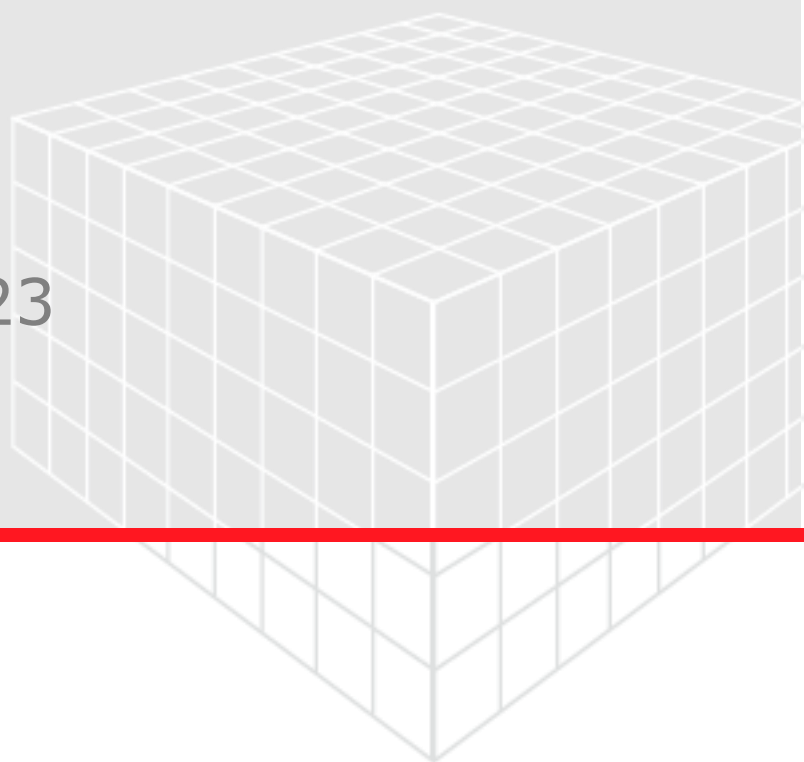

GEO DICT

<https://doi.org/10.30423/userguide.geodict>

© Math2Market GmbH 2023

Citation:

Anne Blumer, Barbara Planas. GeoDict 2023 User Guide. ProcessGeo handbook. Math2Market GmbH, Germany, doi.org/10.30423/userguide.geodict

All rights reserved. It is not permitted to reproduce the book or parts thereof in any form by photocopy, microfilm or other methods or to transfer it into a language suitable for machines, in particular data processing systems, without the express permission of the publisher. The same applies to the right of public reproduction.

The handbooks in the User Guide series of Math2Market GmbH can be obtained from:

Math2Market GmbH
Richard-Wagner-Strasse 1
67655 Kaiserslautern
Germany

Phone: +49 631 205 605 0
Fax: +49 631 205 605 99
Email: info@math2market.de
Web: www.math2market.de

TRANSFORMING AND MODIFYING 3D STRUCTURE MODELS 1

PROCESSGEO SECTION 2

PROCESS 3

Crop	3
Embed	4
Repeat	6
Mirror	6

REASSIGN 7

Reassign Material ID	7
Reassign Material	8
Reassign Material of Material ID	9

DILATE 10

ERODE 13

CLEANSE 17

RESCALE 19

COMPRESS 23

The Algorithm 24

ROTATE 90°, MIRROR, AND PERMUTE 25

ADD BINDER 27

General Options 28

STOPPING CRITERION 28

SOLID VOLUME PERCENTAGE	28
WEIGHT PERCENTAGE	28
GRAMMAGE	29

CONTACT ANGLE	30
BINDER ANISOTROPY FACTOR	31
PERIODICITY	31
STOP ITERATION BY	31

Binder Distribution 32

INVERT 36

CREATE EMPTY GEOMETRY 37

MARK COMPONENTS 38

FLOOD-FILL LARGE PORES 41

TRANSFORMING AND MODIFYING 3D STRUCTURE MODELS

ProcessGeo offers several options to transform structures in **GeoDict**. **ProcessGeo** starts after selecting **Model** → **ProcessGeo** in the Menu bar.

The module section, to the left of the Visualization area, changes to the **ProcessGeo** section.

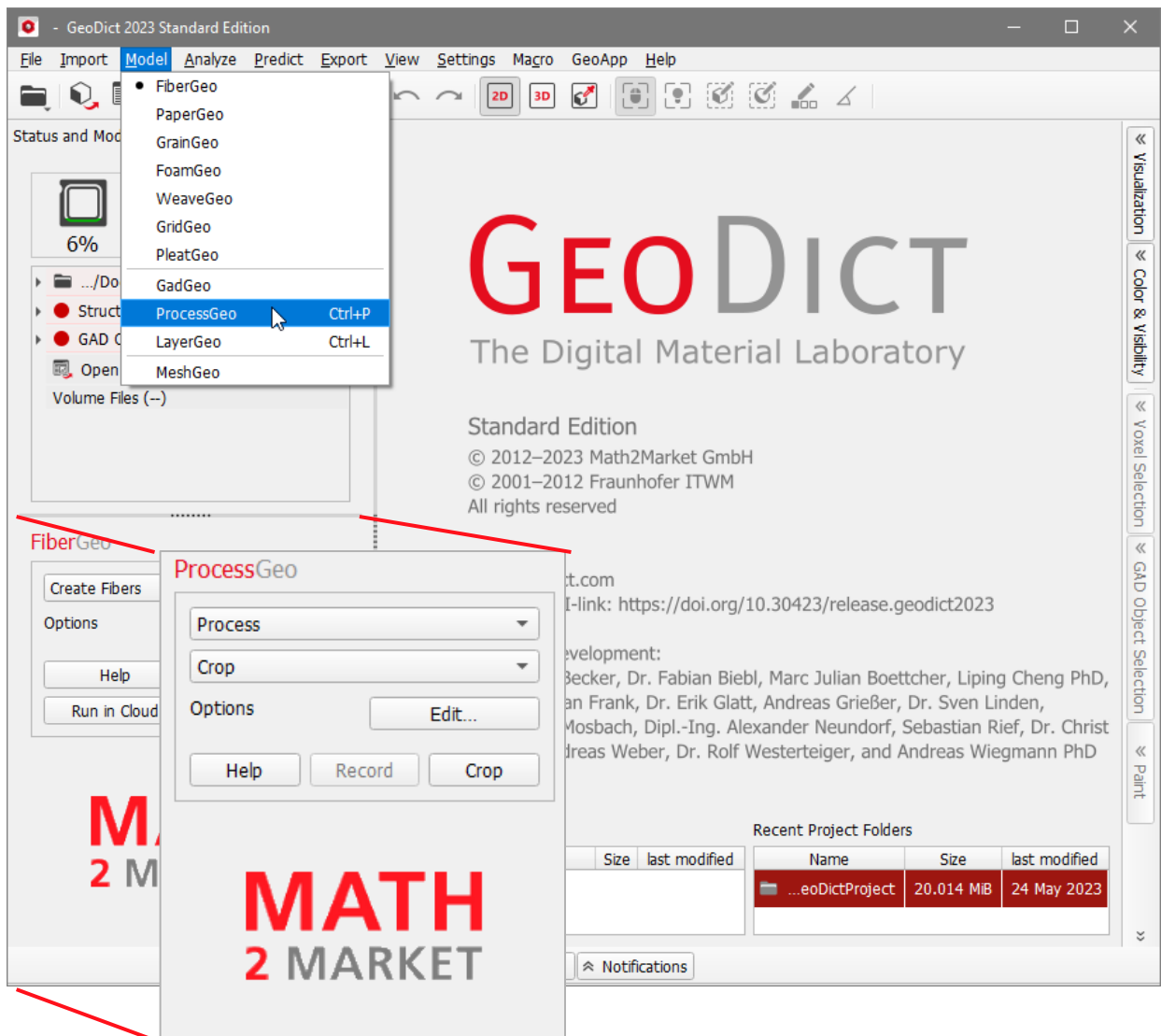

PROCESSGEO SECTION

The operations in **ProcessGeo** can be selected from the pull-down menu. The available options are:

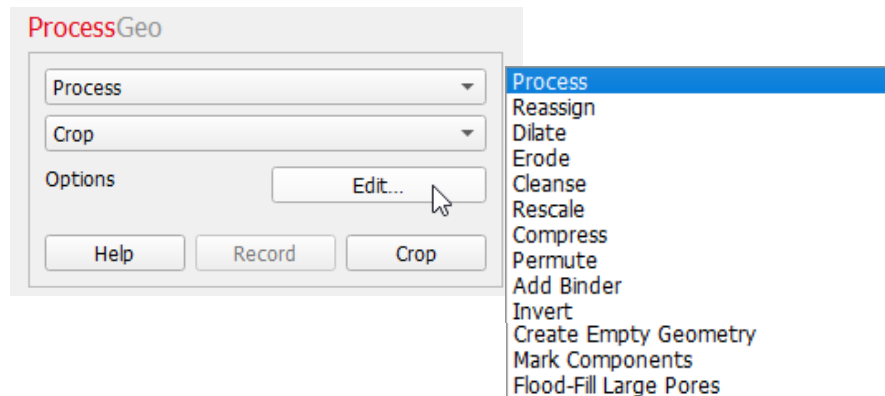

- **Process**
 - **Crop** from the structure
 - **Embed** to add other material(s) to the structure
 - **Repeat** the structure
 - **Mirror** the structure
- **Reassign** to substitute one material (or material ID) for another
- **Dilate** to coat the structure with material
- **Erode** to eliminate material from the structure
- **Cleanse** to remove material components and noise
- **Rescale** to change the structure's resolution
- **Compress** to compact the structure in one direction
- **Permute** to mirror and/or rotate the structure
- **Add Binder** to add binding material where surfaces in the structure are close together
- **Invert** to switch solid voxels to pores and pores to solid voxels. Analytic material information is lost
- **Create Empty Domain** to create an empty domain with dimensions NX, NY, and NZ
- **Mark Components** to mark all solid components or pores connected to the domain sides
- **Flood-Fill Large Pores** to change the material in all pores that have a larger diameter than a specified value.

To carry out one of the available operations, select it from the pull-down menu, click the **Options' Edit...** button and enter the necessary settings in the opening dialog. Close the dialog by clicking **OK** and click the button corresponding to the operation in the module section.

For the **Invert** command no options are available. Simply click **Invert** in the **ProcessGeo** section.

PROCESS

In many cases, it might be necessary to transform structures, in order to build a new structure.

For example, the **LayerGeo** module is used to combine 3D volumes. For this, the dimensions of the merged structures must be compatible. Thus, to merge two structures in **Z** direction, the dimensions in the **X-** and **Y-**direction must be the same.

For this type of operations, it can be useful to **crop** parts of the structure, grow the structure through **embedding**, and **repeat** or **mirror** the structure.

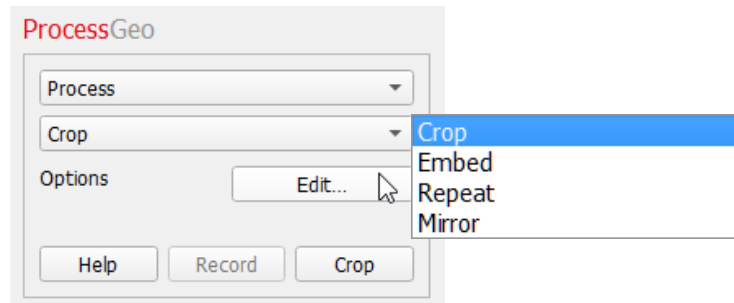

To add or delete voxels of space in **X-**, **Y-**, or **Z-**direction, click the **Options' Edit...** button.

CROP

Crop a part of the structure in the selected direction by the (integer) values entered in **X-**, **X+**, **Y-**, **Y+**, **Z-**, and/or **Z+**.

These values can also be selected by moving the sliders for **NX**, **NY**, and **NZ** or by directly entering the values. The first value determines what is cut away at the beginning of the structure. This value is identical to the value entered in **X-**, **Y-** and **Z-** respectively. The second value determines the end of the cropped structure. It is equal to **NX-X+**, **NY-Y+**, and **NZ-Z+**, respectively.

Checking **Automatically Crop Pore Space** results in removing slices of the 3D model at the boundary that contain only a material ID that has been assigned as pore space. In this case, the previously shown settings cannot be made.

With **Preview Crop** checked, the result of the cropping process is previewed in the Visualization area. The **Use Structure Clipping** button allows to copy the current structure clipping (from the current visualization) as input parameters for cropping.

By checking **Crop Volume Fields**, any loaded volume fields are also cropped to the new geometry size during the cropping operation.

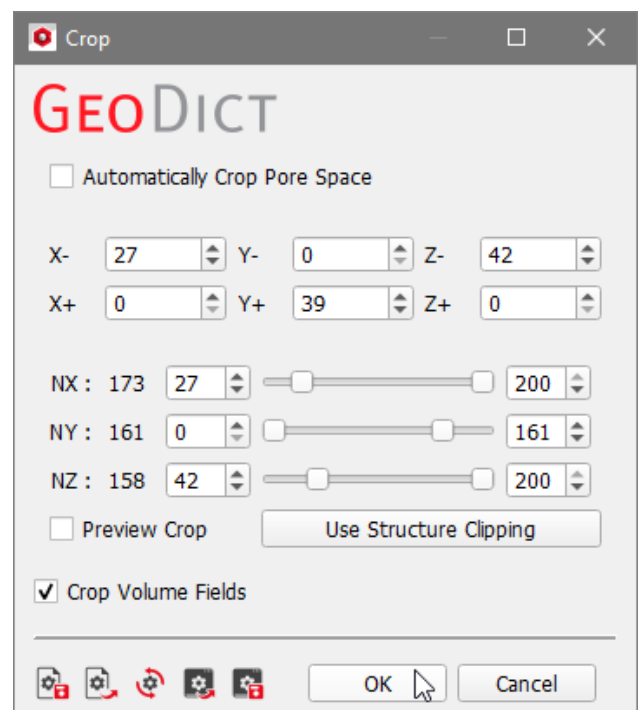

Transforming and modifying 3D structure models

The structure's analytic information is preserved when cropping, as indicated by the green dot in front of **GAD Objects** in the project status section.

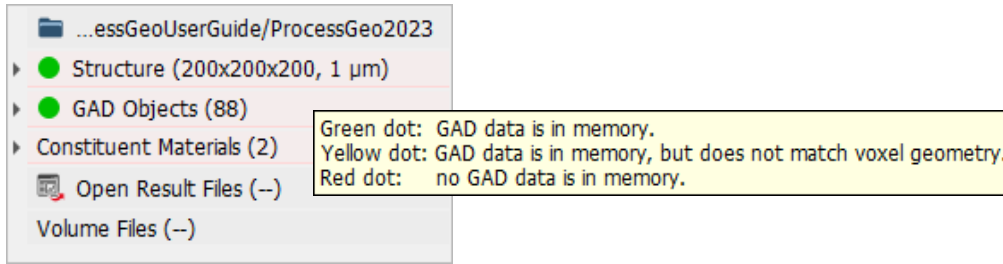

EMBED

With **Embed**, the domain is enlarged by the defined number of voxels in the directions **X-**, **X+**, **Y-**, **Y+**, **Z-** and **Z+**. The added voxels get the material ID selected under **Embed with Material ID**.

For **Embed**, it is possible to keep the original structure's analytic information if the user checks **Embed Analytic Objects** and then clicks **OK** and **Embed** (in the ProcessGeo section).

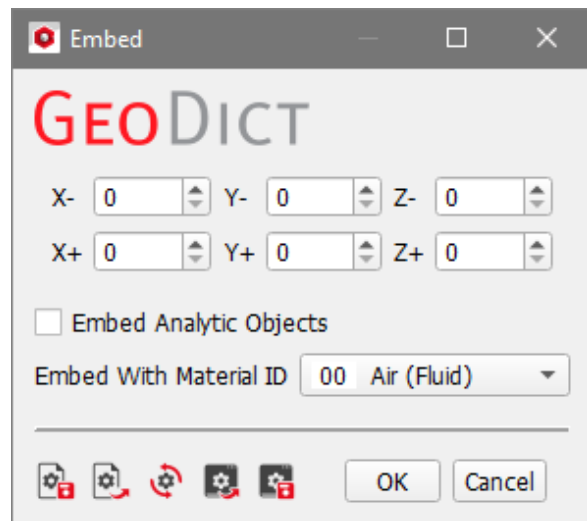
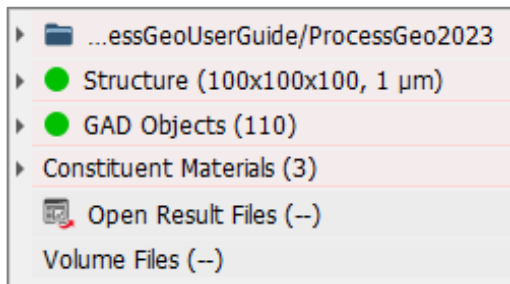

As noted above, in the project status section, a green dot in front of **Objects** indicates that analytic data is in use.

The dot changes to red when the structure's analytic information is lost.

The red dot indicates that no GAD data is in memory.

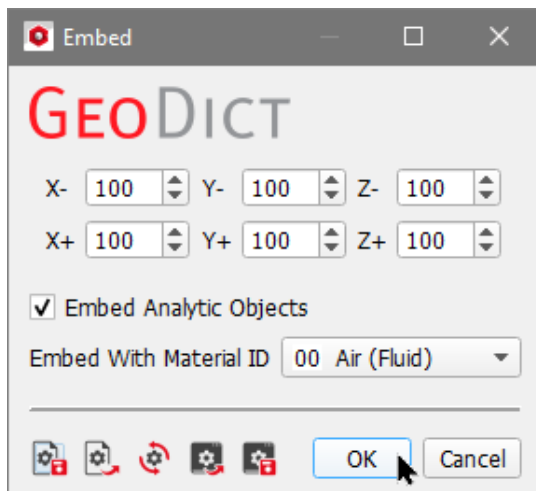
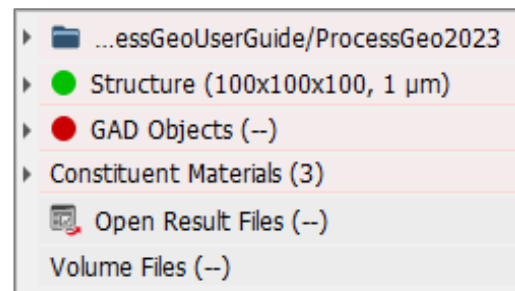

Observe the difference in embedding 100 voxels of Air (Material ID 00) in all directions (X+, X-, Y+, Y-, Z+, Z-) to a fibrous structure with fibers of infinite length saved in a GAD file. The 150 μm-long fibers extend beyond the 100 x 100 x 100 domain.

Check **Embed Analytic Objects**, click **OK**, and then, click **Embed**.

The analytical information of the fibers in the original GAD file is kept and the fibers can be observed penetrating the region of the embedded voxels.

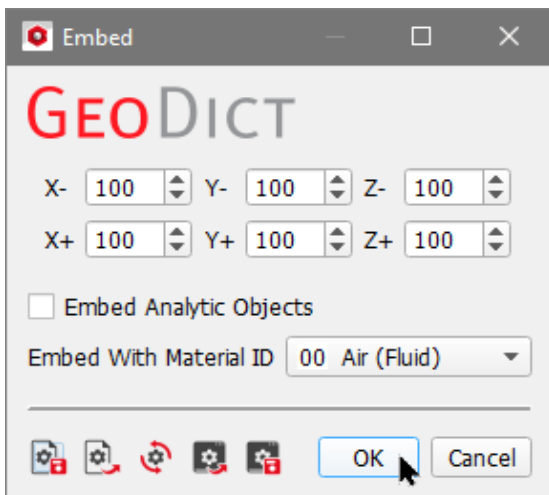
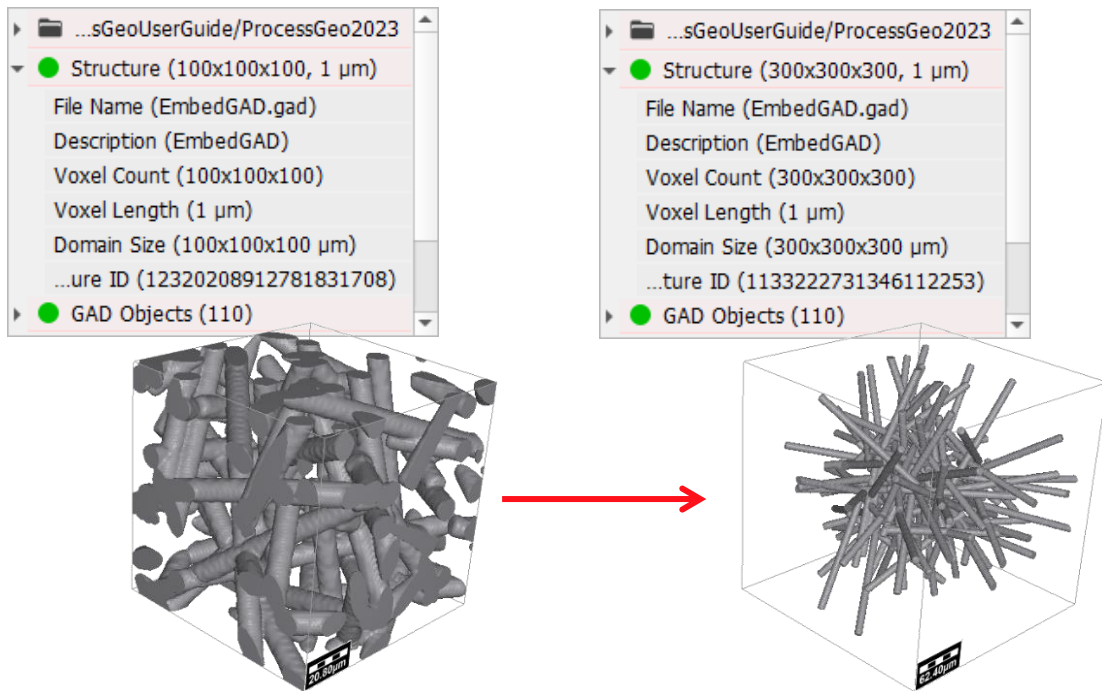

Now, leave **Embed Analytic Objects** unchecked instead, click **OK**, and then, click **Embed**.

The analytic information of the fibers that is beyond the domain is lost and the fibers are seen ending at the boundary of the newly embedded voxels.

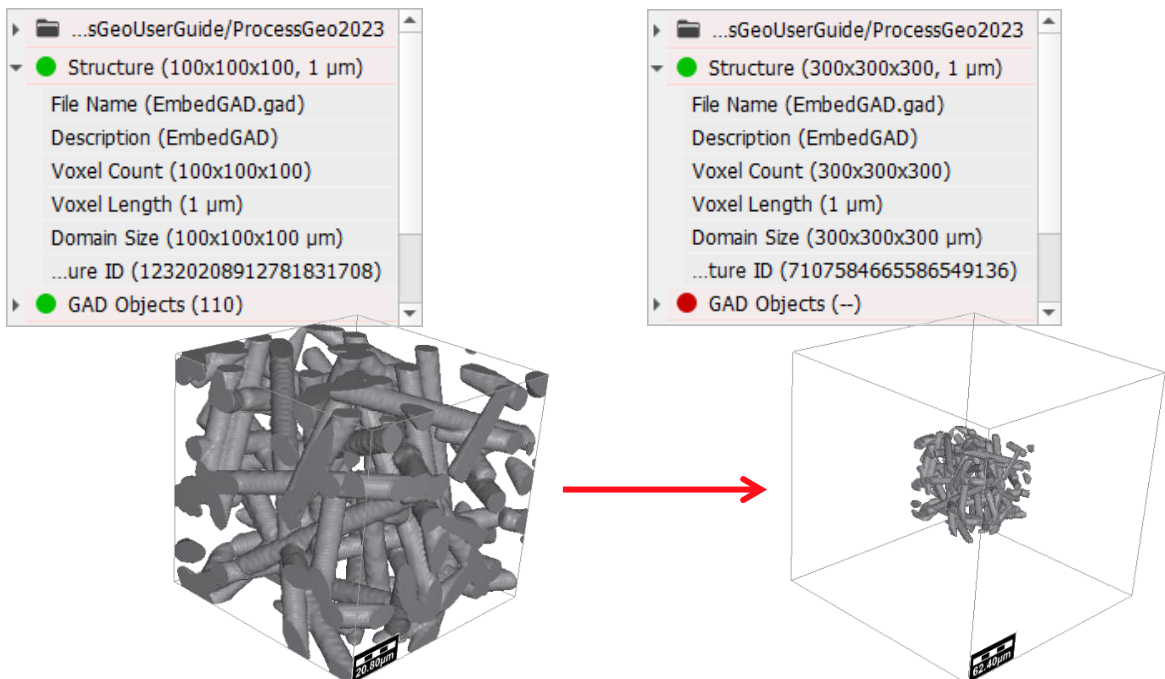

REPEAT

With **Repeat** the structure is repeated in the direction and by the values entered in the **X-**, **X+**, **Y-**, **Y+**, **Z-** and **Z+** boxes.

The structure's analytic information is always lost when performing the process of **Repeat**.

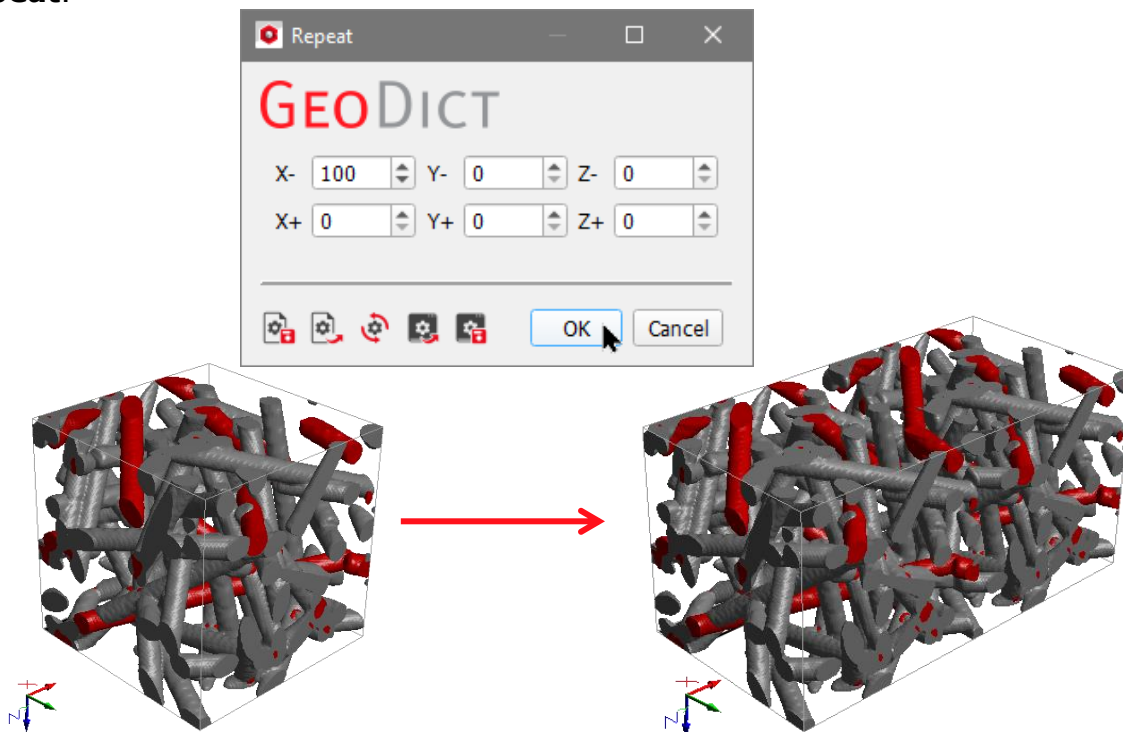

MIRROR

With **Mirror** the structure is mirrored in the direction and by the values entered in the **X-**, **X+**, **Y-**, **Y+**, **Z-** and **Z+** boxes.

The structure's analytic information is always lost when performing the process of **Mirror**.

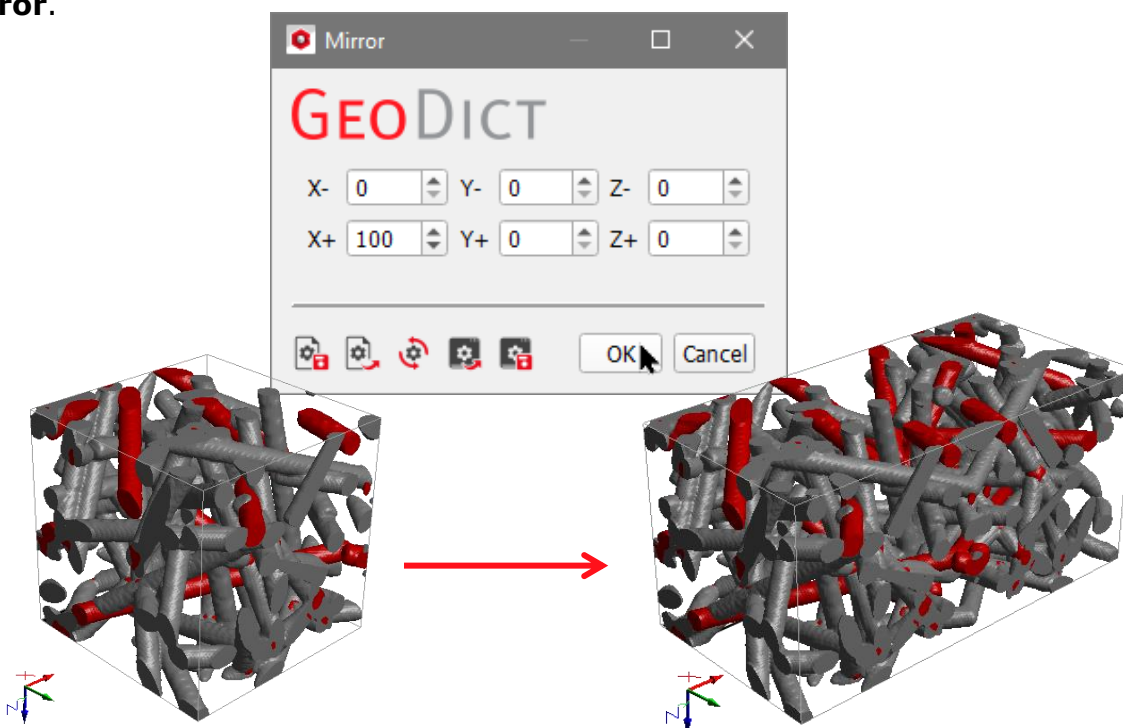

REASSIGN

With **Reassign**, materials and material IDs in the structure can be changed to other materials.

Choose between the options **Reassign Material ID**, **Reassign Material**, and **Reassign Material of Material ID**.

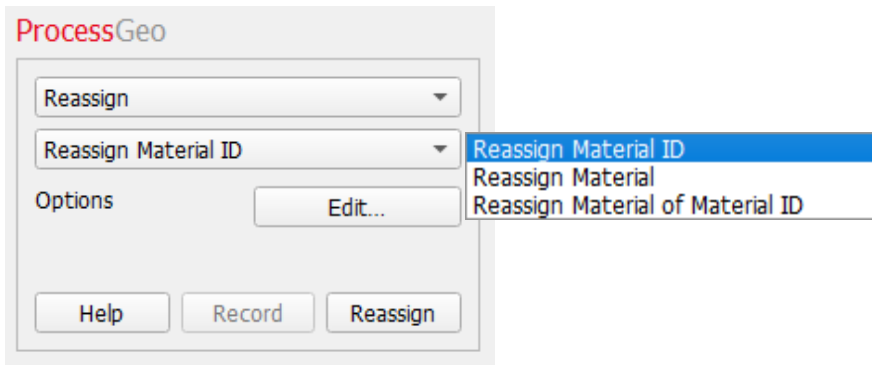

Then, click the **Options' Edit...** button.

REASSIGN MATERIAL ID

This assigns a new Material ID (**New Material ID**, here: 03) to voxels with a given Material ID (**Old Material ID**, here: 01).

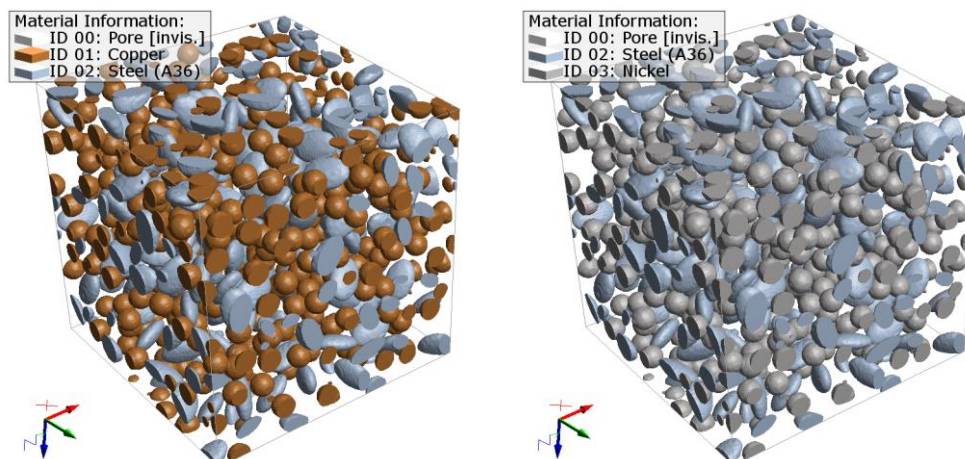
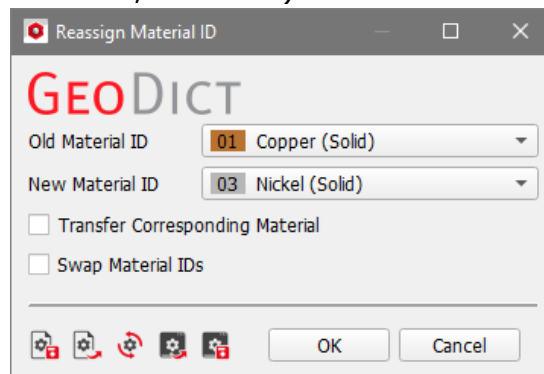

Transforming and modifying 3D structure models

With the additional option **Transfer Corresponding Material** also the material of the old Material ID is changed to the material of the new Material ID.

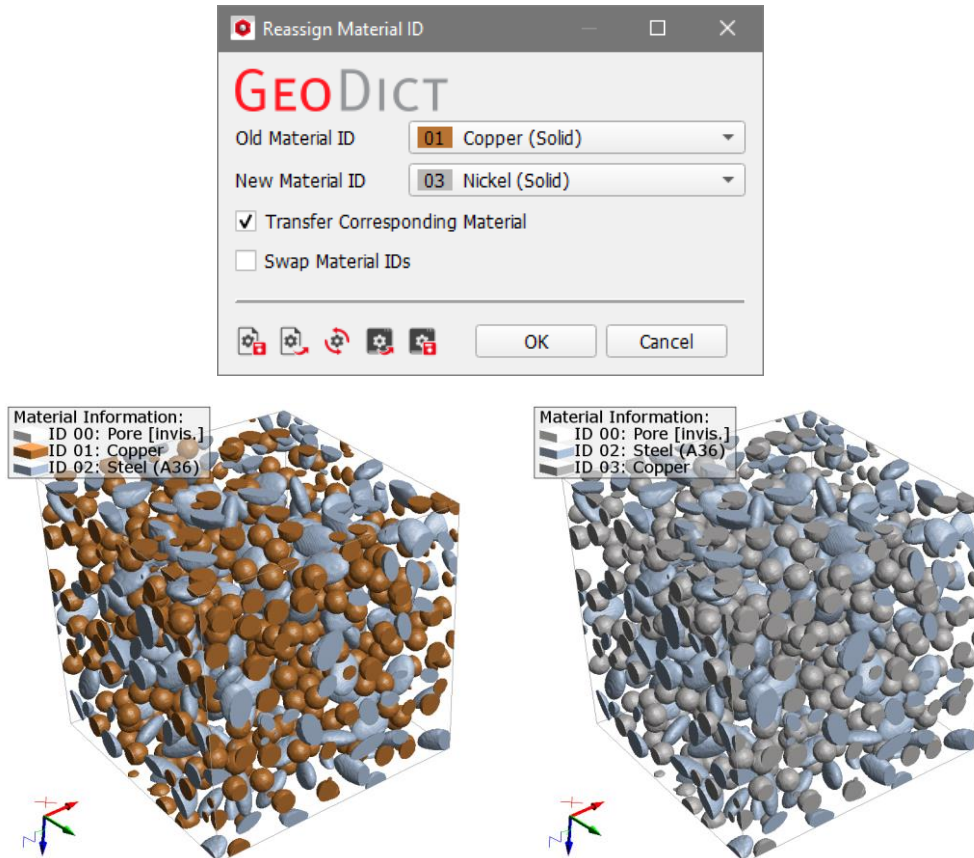

Using **Swap Material IDs** allows to swap the old and new Material ID.

REASSIGN MATERIAL

Reassign Material assigns a new material (**New Material**, here: Nickel) to all voxels (independent of their Material ID) of another material (**Old Material**, here: Copper) from the **GeoDict** Material Database. The material IDs are not changed but the material ID itself receives a new set of properties from the Material Database.

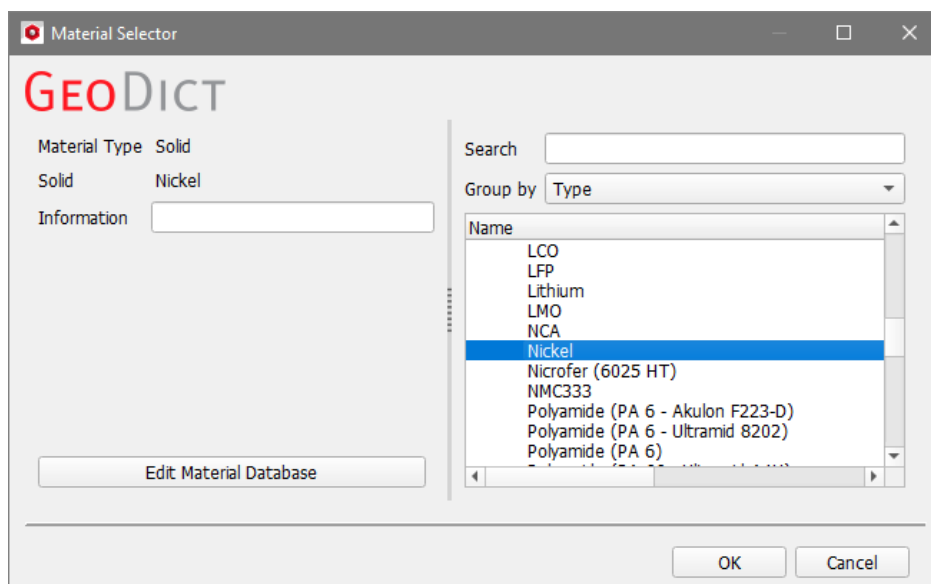

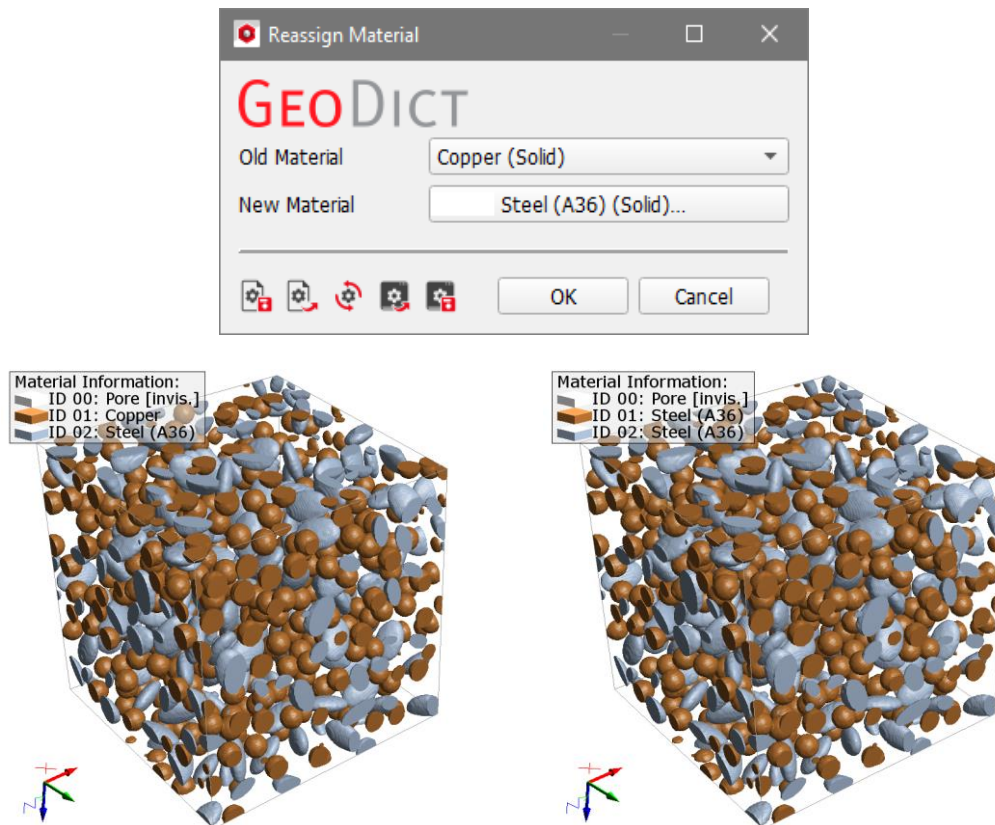

REASSIGN MATERIAL OF MATERIAL ID

Reassigning a material to a material ID only changes the material (here: Copper) for the specified material ID to another material (here: Nickel) selected from the database. The material ID itself does not change. This command is especially helpful, if several material IDs have the same material, but the material should only be changed for a certain material ID.

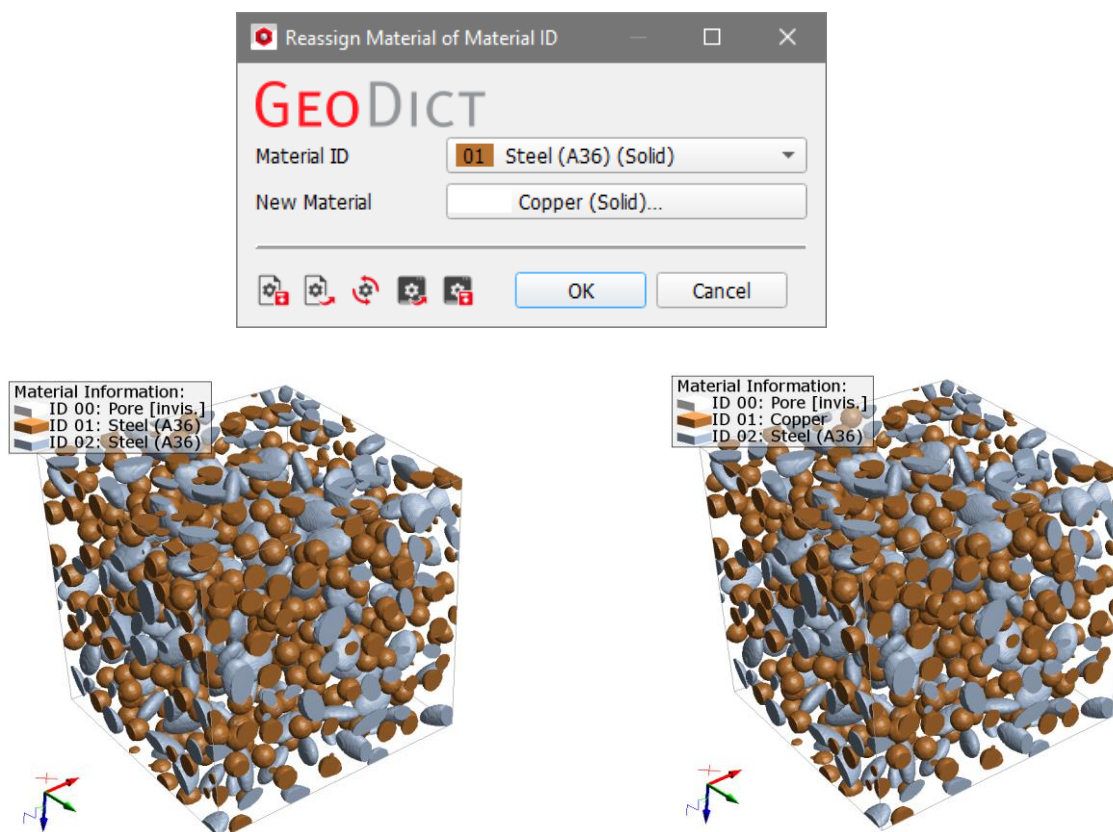

DILATE

Dilate performs the morphological operation *dilation* on the selected material (**Dilate Material ID**) by the number of voxels (or the thickness) entered in **Dilate by....**

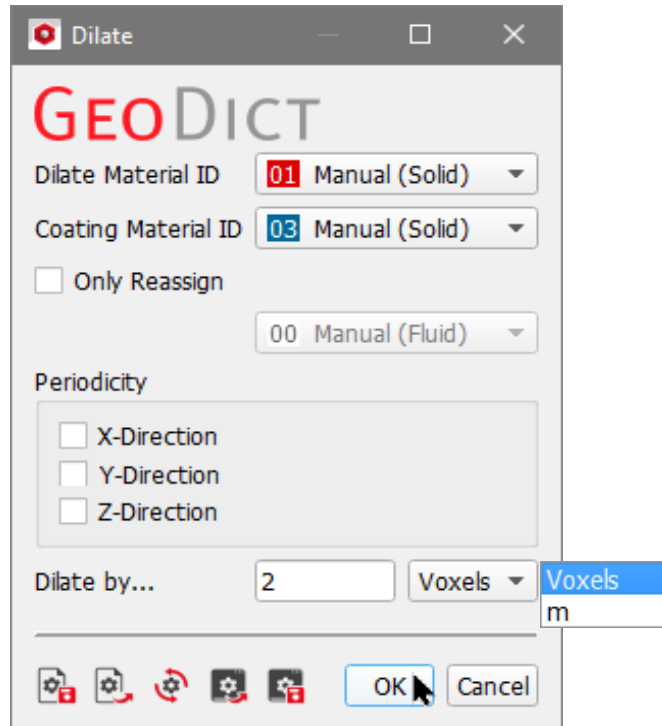
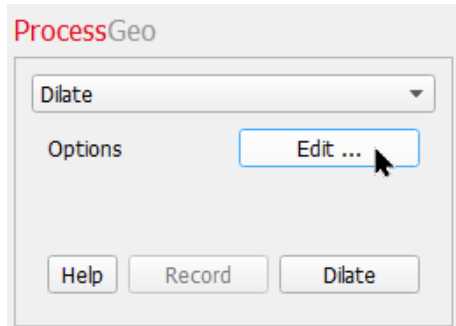

The dilation appears as a coating in the selected **Coating Material ID**.

The coating material can be selected to be the same as the material to dilate, for example to increase the diameter of fibers or grains in the structure.

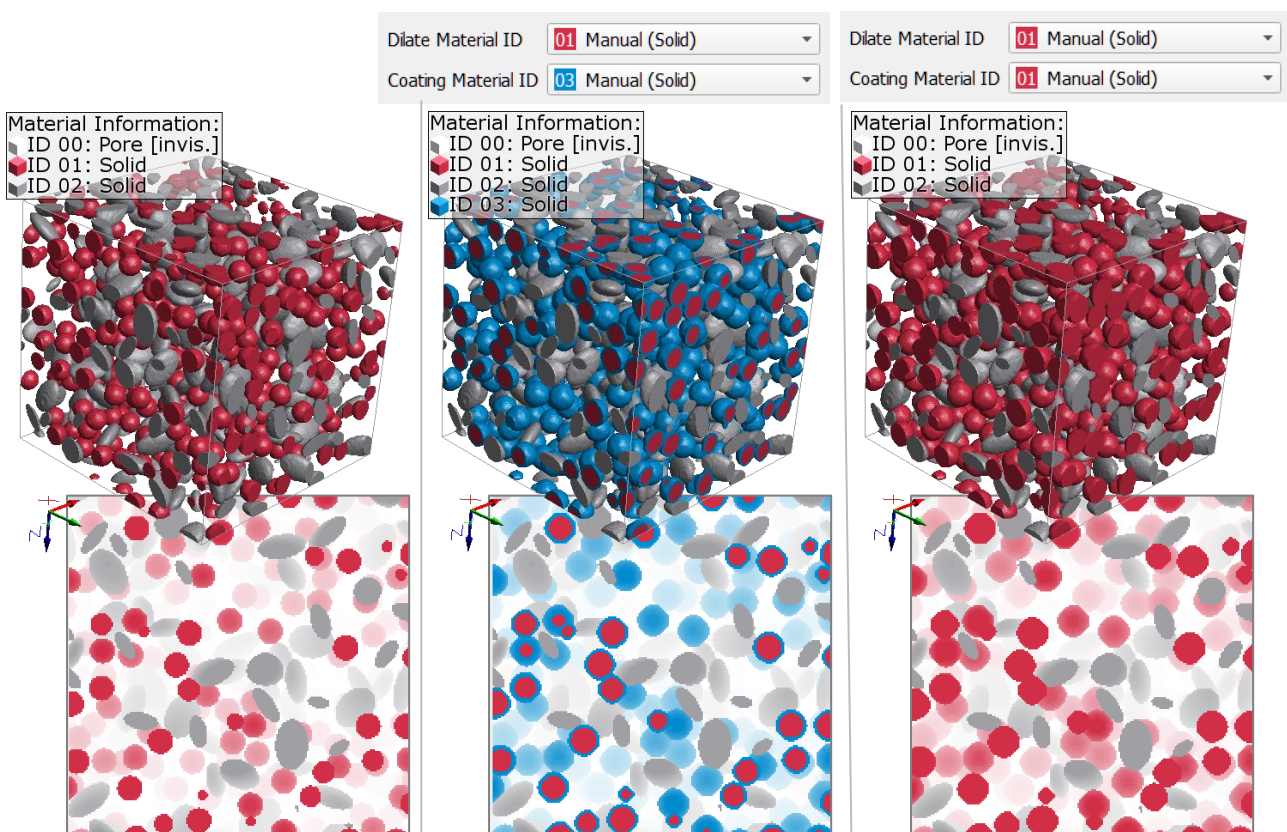

When checking **Only Reassign** and choosing a material ID from the pull-down menu (e.g. ID 02), only voxels of this material ID (here: grey) are replaced by voxels of the **Coating Material ID** (e.g. 03, here: blue). This occurs only for grey voxels located at a certain distance or less (defined in **Dilate by...**, e.g. 5 voxels) from voxels of the **Dilate Material ID** (e.g. 01, red). The blue coating (03) appears only on some of the grey grains.

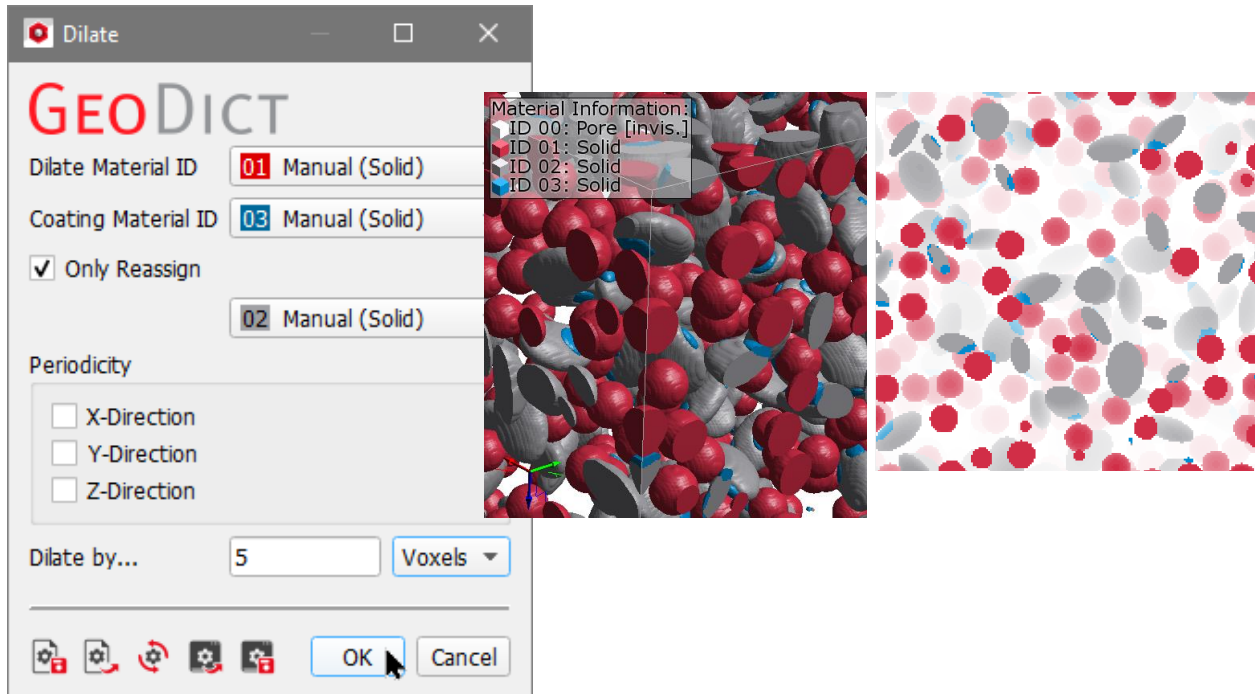

When the **Dilate Material ID** is changed to 02 (grey) and the **Only Reassign** is chosen to be 01 (red), the blue coating (03) appears now only on some red grains.

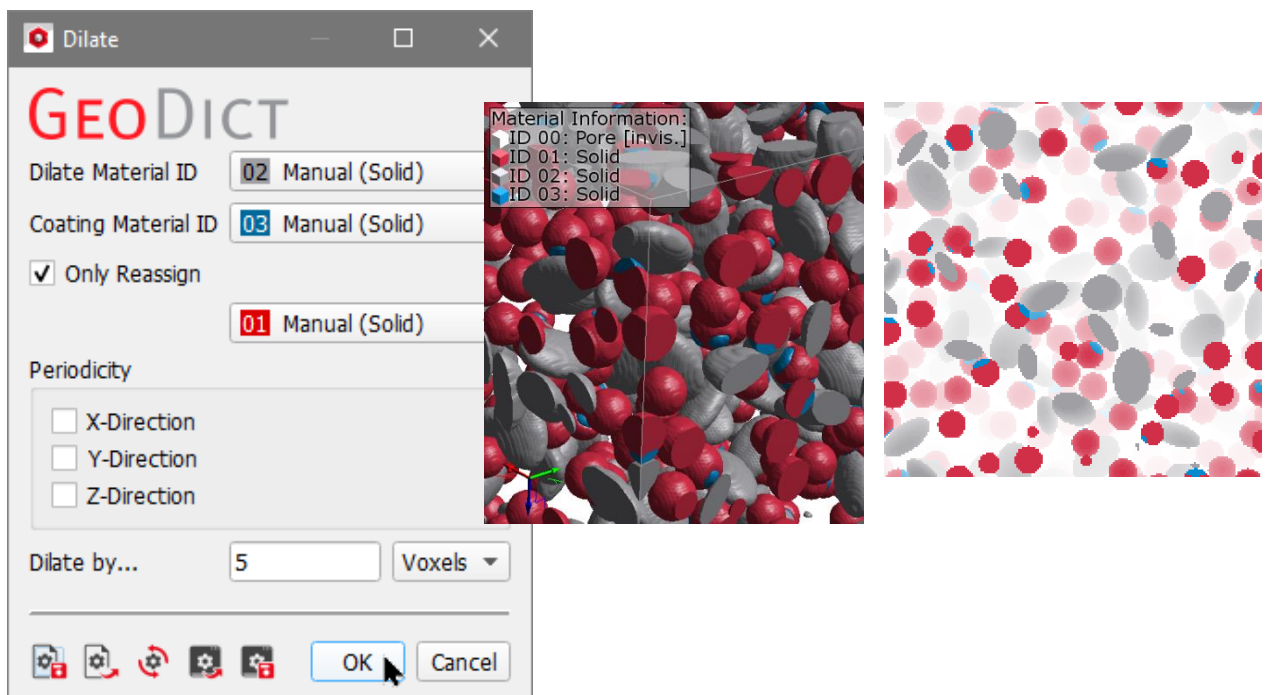

Transforming and modifying 3D structure models

For periodic 3D-structure models, the user can choose to dilate the materials in the structure periodically in all directions, only in one (or more) selected direction(s) (**Periodic X**, **Periodic Y** and/or **Periodic Z**), or non-periodically (symmetrically).

For example, compare the effect of dilating periodically. When periodicity is applied, the blue coating of the red fiber continues on the opposite side of the domain (see the blue spot on the left side).

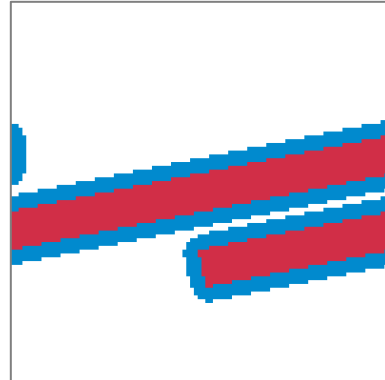
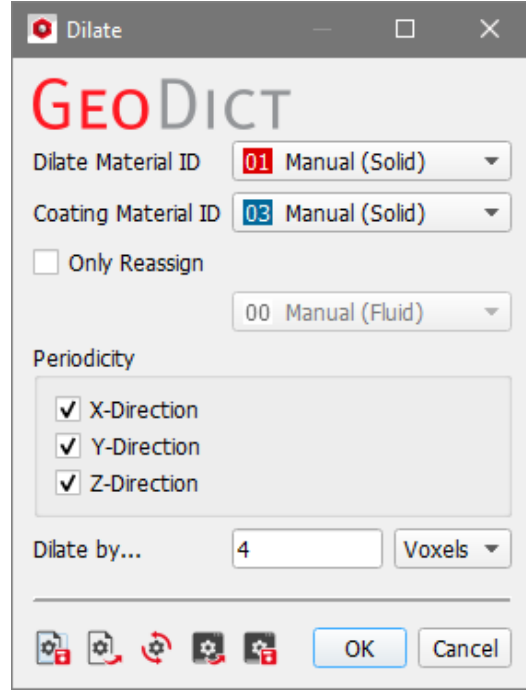
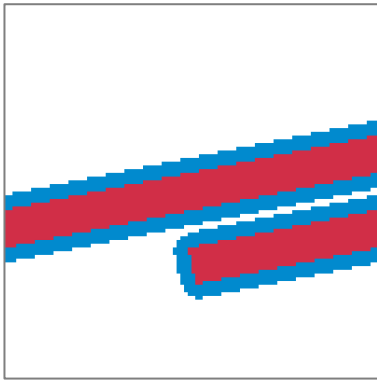
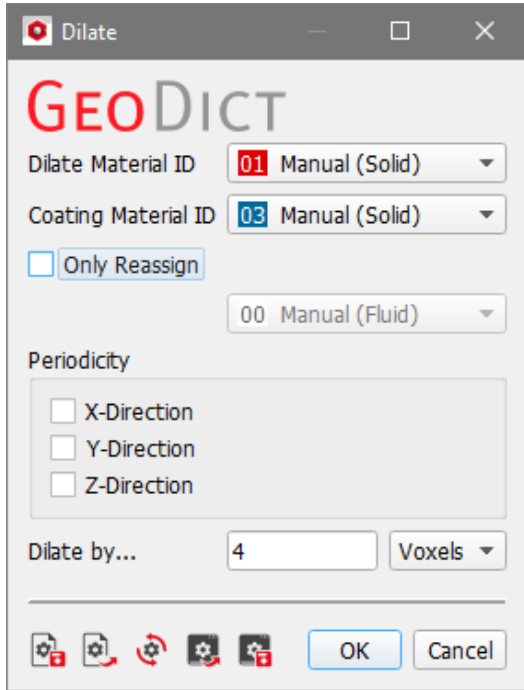

ERODE

An erosion operation is done on the objects of all solid materials in the structure, by the number of voxels entered in **Erode by....** The erosion process occurs by the empty voxels (white) invading the solid voxels (red) and can be applied also periodically in any of the three directions or in all of them.

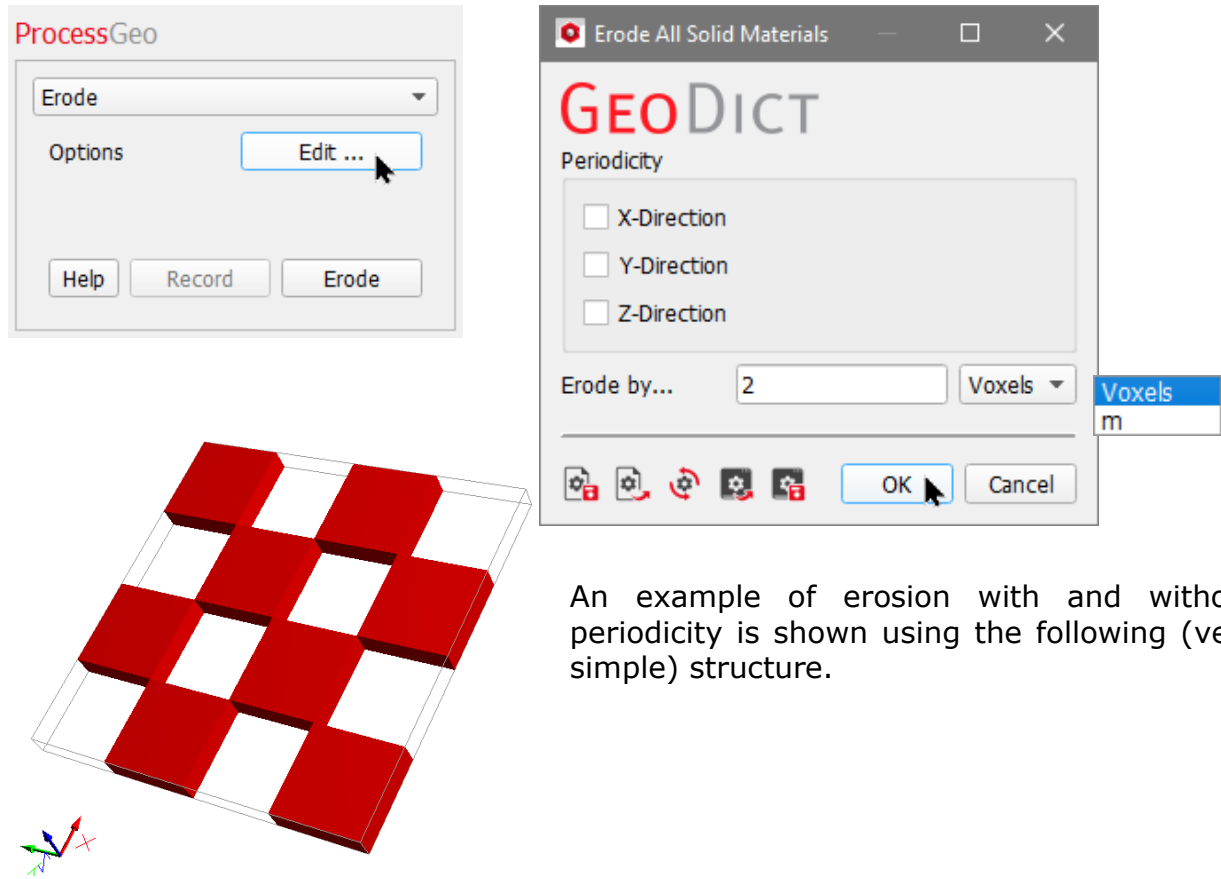

An example of erosion with and without periodicity is shown using the following (very simple) structure.

Each of the eight solid objects in the structure is made of 16 red voxels. Each group of solid voxels forming an object alternates with empty space (such as pore space) made of 16 white voxels.

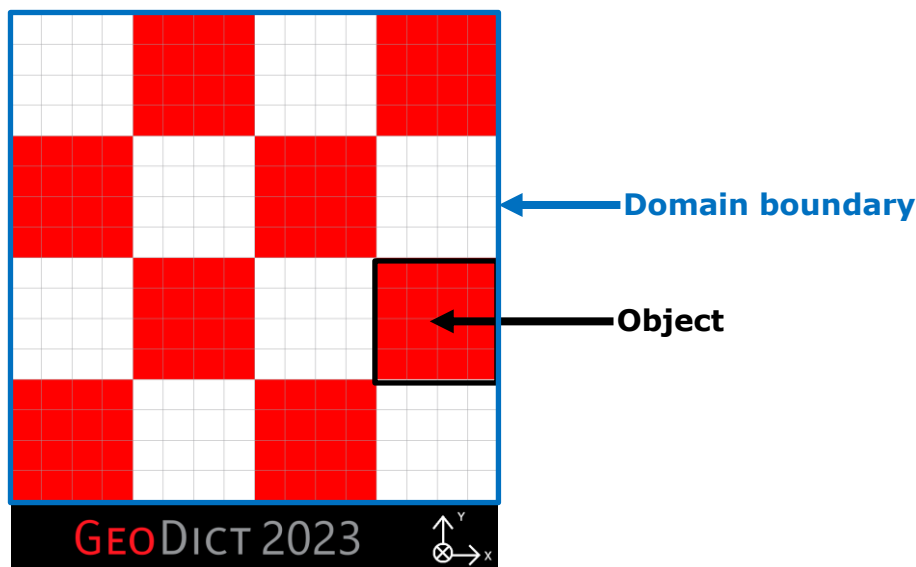

Transforming and modifying 3D structure models

Without the **Periodicity** checkboxes selected, the solid objects (red) are eroded by 1 voxel anywhere an empty voxel (white) touches a solid voxel (red). However, at the boundaries of the domain, where no white voxels are present and no periodicity has been assigned, the red voxels are not eroded.

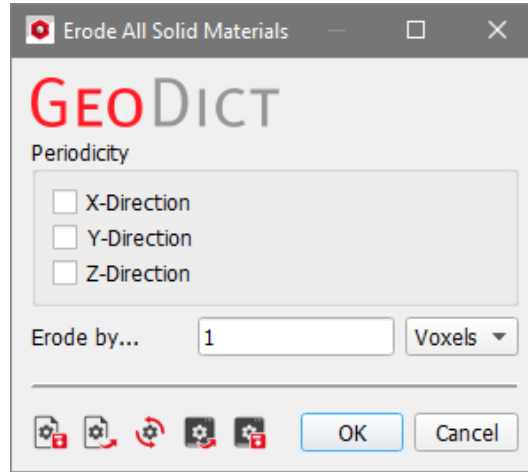
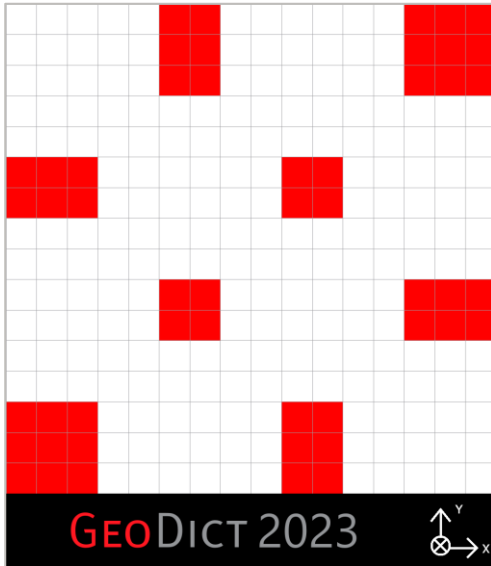

After setting the periodicity in X-Direction and in Y-Direction and choosing again to erode by 1 voxel, the objects are eroded also from the boundaries of the domain.

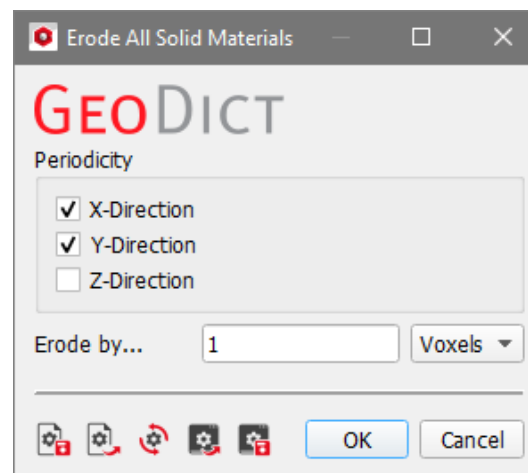
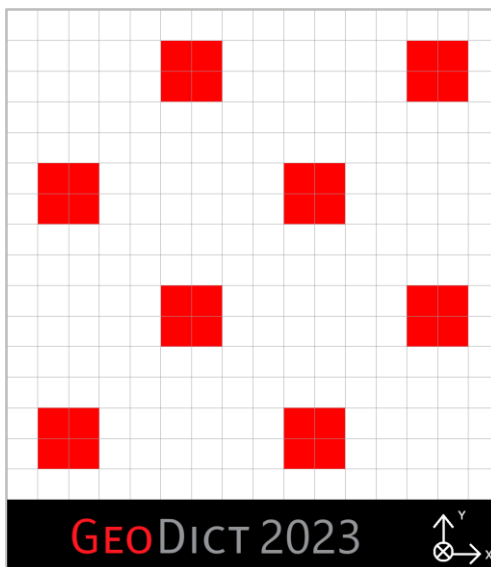

This occurs because, by setting this periodicity in X- and Y-Direction, it is assumed that beyond the domain boundaries there is a periodic copy of the complete structure. In our example structure, this periodic copy places empty voxels (white) immediately adjacent to the solid voxels (red) of the example structure. These white voxels erode the red voxels at the domain boundary.

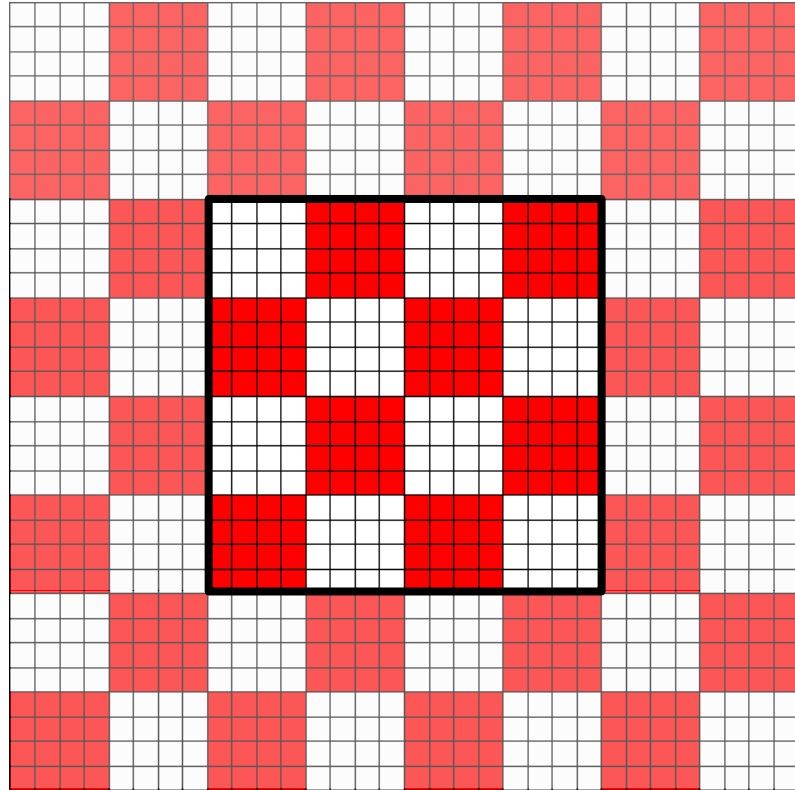

Finally, observe that by setting the periodicity only in X-Direction, or only in Y-Direction and choosing to erode by 1 voxel, the objects are eroded from the boundaries only in X-Direction or only in Y-Direction.

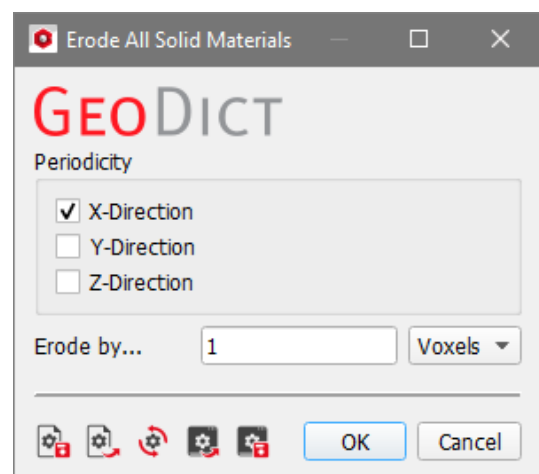
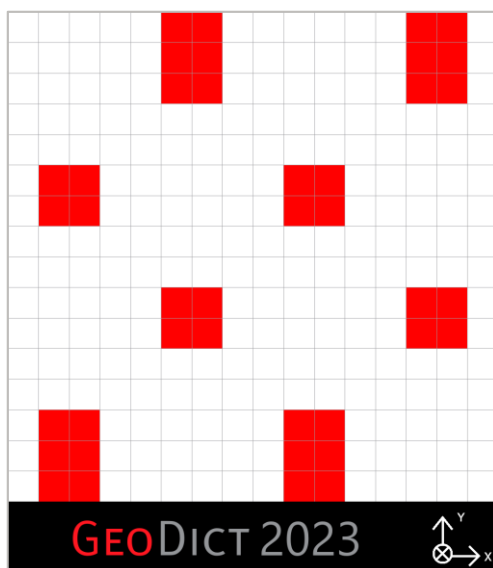

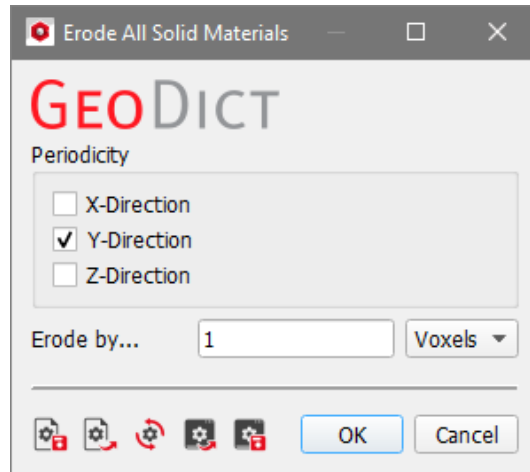
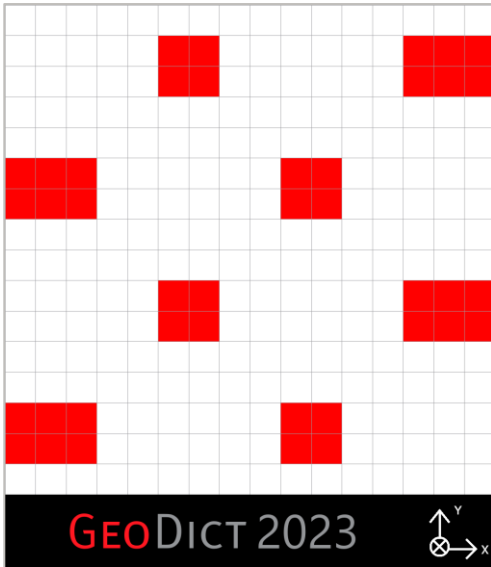

CLEANSE

Cleanse removes small, connected components from the structure. It is well suited to filter out the noise in a structure generated after importing and thresholding a 3D grey-value image from a CT-scan.

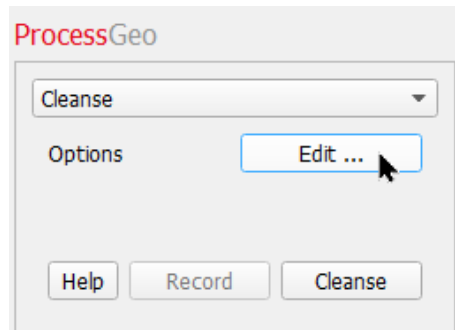

The structure can be cleansed periodically in all directions, or only in the selected direction (**Periodicity** in **X-Direction**, **Y-Direction** and/or **Z-Direction**). If no direction is chosen it is cleansed non-periodically (with symmetric boundaries).

The selections in the **Neighborhood** panel determine which voxels are detected as connected. Checking **Face** is more restrictive than choosing **Face or Edge**. The most permissive **Neighborhood** condition is **Face, Edge or Vertex**.

Select the material ID of the connected components to be removed (**Material to Cleanse**) and the material ID to be applied to the cleansed components (**New Material ID**). If the material to cleanse is set to **All**, the **New Material ID** is the material ID of the largest surrounding connected component.

Cleansed are all connected components of the specified material ID which contain only the given **Number of Voxels** or less.

In this example, **Cleanse** is applied to an imported structure with high levels of noise in the CT image, leading to unwanted components. Here, it is shown how small unconnected components, with less than 10 voxels, are removed with the cleansing.

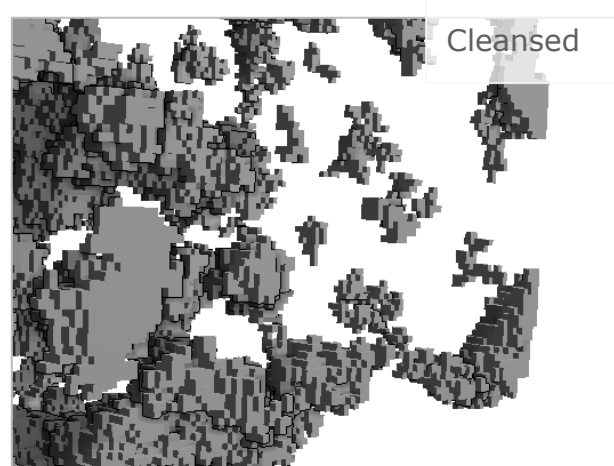
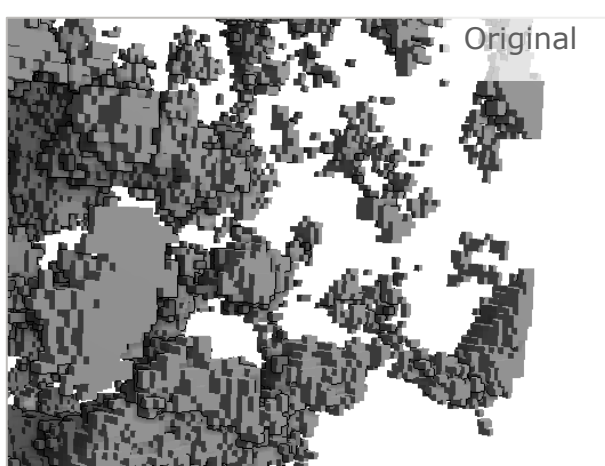

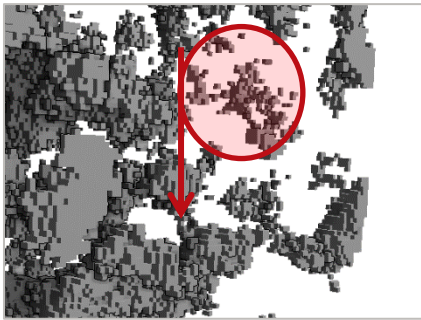

Taking a closer look at the uncleaned structure we see examples for the different cases.

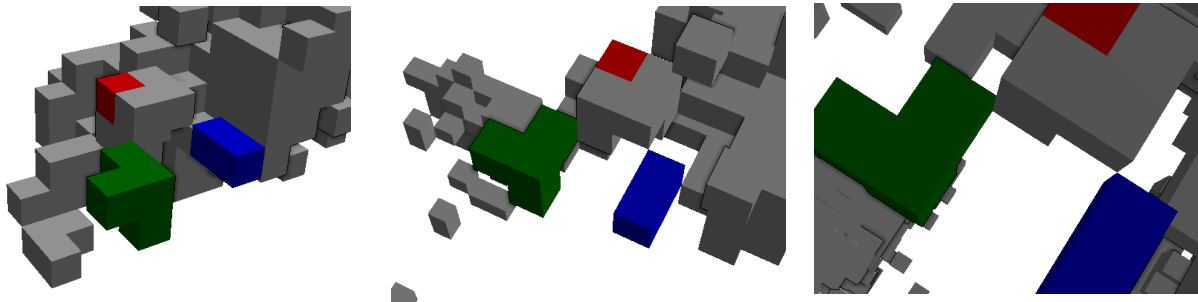

If we choose **Face**, only voxels connected with face contact to at least 10 other voxels (**Number of Voxel** option) remain. The red voxel shown above is connected to the other voxels by faces.

If we choose **Face or Edge**, also voxels connected to at least 10 other voxels over edges remain. The group of green voxels shown above is connected to the other voxels at the edges.

If we choose **Face, Edge or Vertex**, also voxels connected to at least 10 other voxels over vertex / corner stay. The group of blue voxels shown above is connected to the other voxels at the vertex or corner.

<input checked="" type="radio"/> Face	
<input type="radio"/> Face or Edge	
<input type="radio"/> Face, Edge or Vertex	

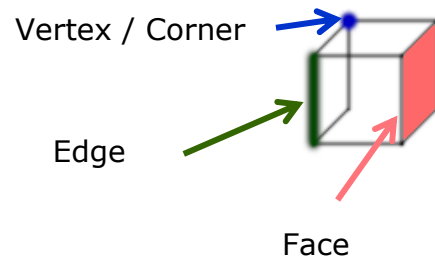

RESCALE

The **Rescale** operation changes the resolution of a structure by changing the size and the number of voxels. The result is a change in voxel length and a corresponding change of the voxel count in the domain by the entered **Grow Factor** or **Shrink Factor**.

Grow Rounded is always applied with a **Grow Factor** of 2 and **Shrink** with a **Shrink Factor** of 2. **Grow Strictly** accepts any positive integer as **Grow Factor** (for example, 3).

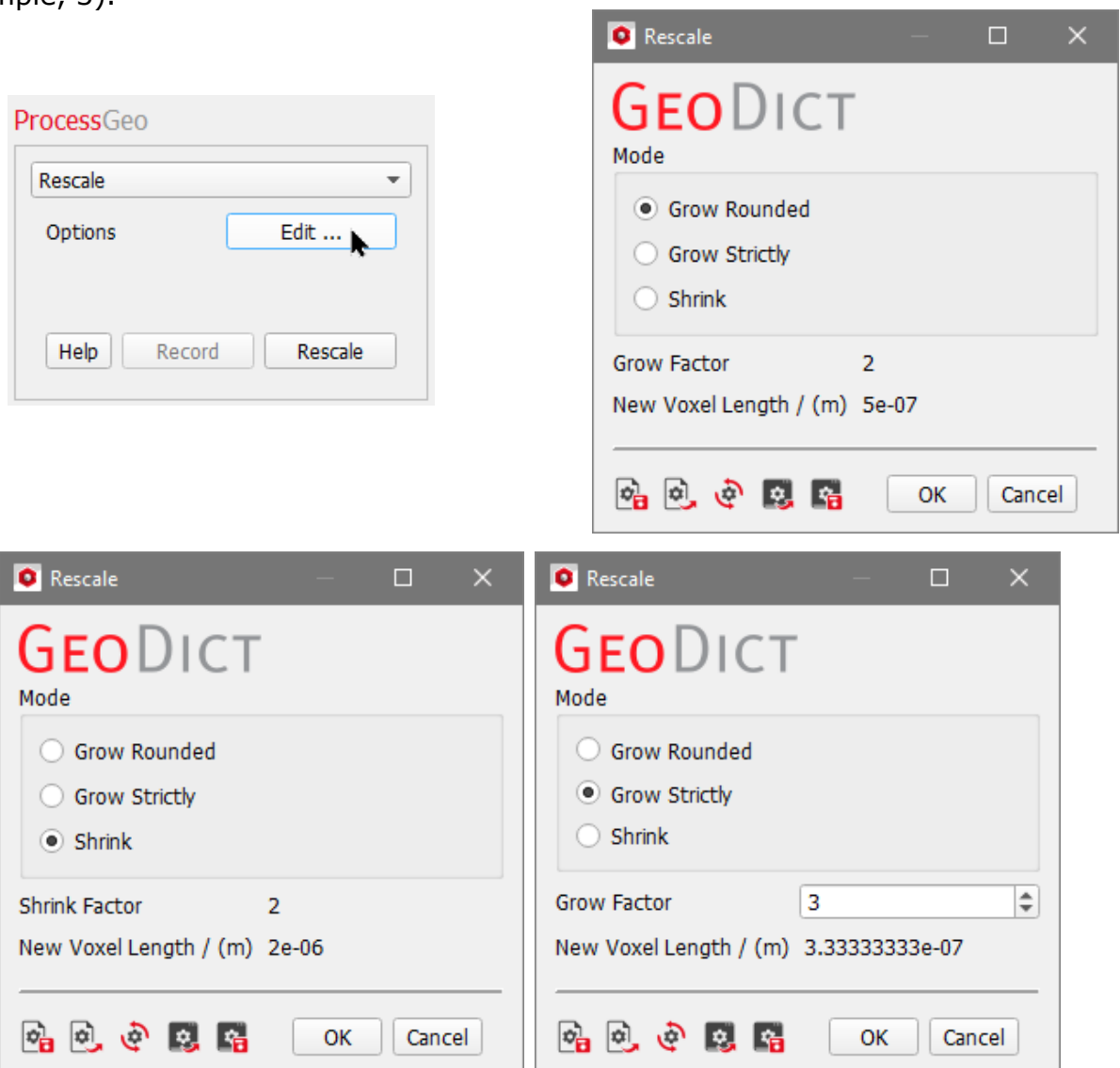

The different rescaling processes are clarified in the illustration below, considering a group of four voxels. The red squares represent solid structure voxels, and the white squares represent empty background voxels.

The internal process of **Shrink** follows the guidelines of “when 50/50, prefer solid over empty” and “in other cases, the majority wins”.

The **Grow Rounded** method fills empty grown voxels when at least two face neighbors are solid. If possible, the analytic data is used for **Grow Rounded** to achieve even better results.

Grow Strictly discards the analytic data instead.

Transforming and modifying 3D structure models

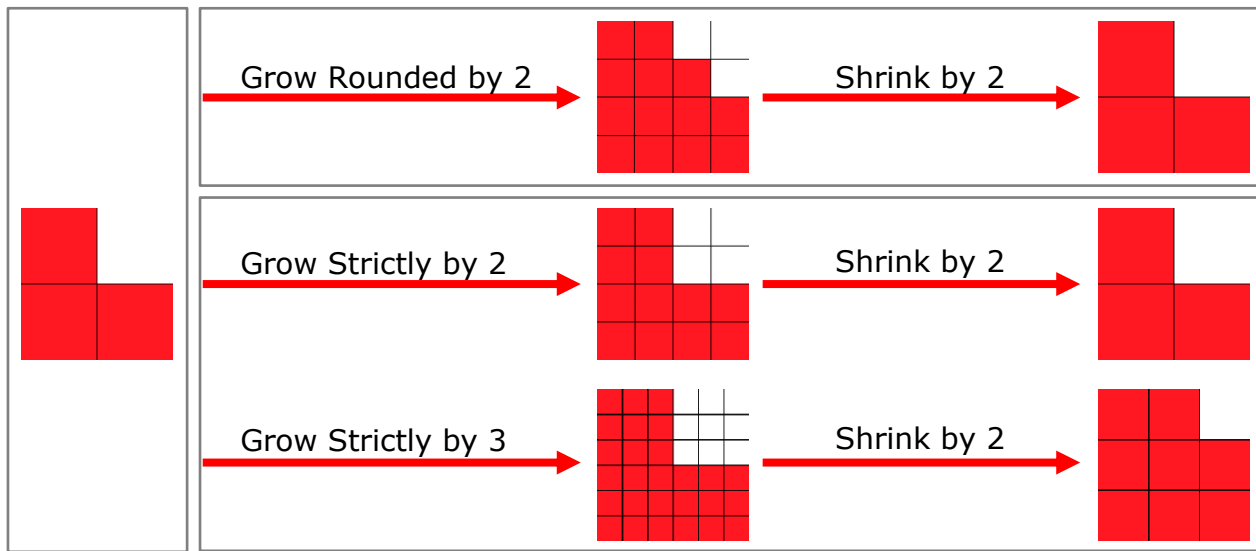

Visually, there is a smoothing of the structure when applying **Grow Rounded**, and a coarsening when applying **Shrink**.

The screenshot shows the software interface for the 'Grow Rounded' and 'Shrink' operations. The interface includes a 3D view of the structure and a properties panel.

Grow Rounded:

- Structure (320x320x320, 500 nm)
- Description (GadGeo>EditDomain)
- Voxel Count (320x320x320)
- Voxel Length (500 nm)
- Domain Size (160x160x160 μm)
- Structure ID (14648279653159436653)
- GAD Objects (4)
- Constituent Materials (2)

Shrink:

- Structure (80x80x80, 2 μm)
- Description (GadGeo>EditDomain)
- Voxel Count (80x80x80)
- Voxel Length (2 μm)
- Domain Size (160x160x160 μm)
- Structure ID (5029317334733285685)
- GAD Objects (4)
- Constituent Materials (2)

The best way to observe the visual effect of rescaling is to use the 3D visualization. With a structure in the Visualization area, select **View** → **3D Rendering** in the menu bar or click the  icon in the toolbar.

In the Visualization panel, above the Visualization area, click the **Structure** tab. Change the **Structure Renderer** to **Box**.

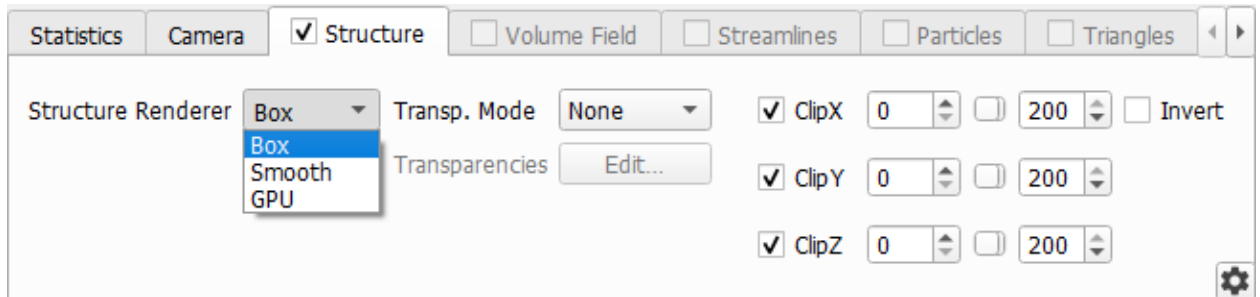

Zoom into the structure by pressing and holding the mouse's right button while moving the mouse.

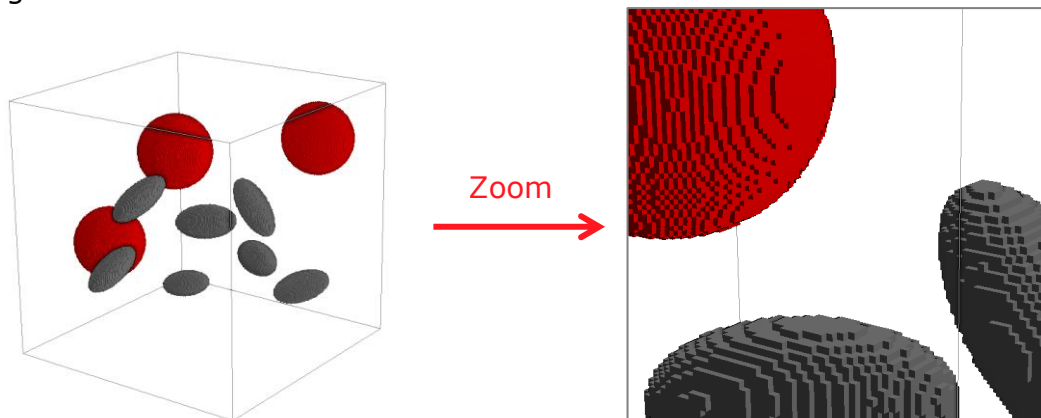

Now switch to **ProcessGeo - Rescale** and check **Grow Rounded**. Click **OK** and then, the **Rescale** button.

The voxel size is divided by 2 (now 0.5 μm) and the domain doubles (now 400x400x400). To further visually smooth the objects in the structure by rounding, the **Rescale** button can be clicked again as needed. The GAD Data is maintained. When no GAD Data is loaded the internal procedure described on the previous page is used.

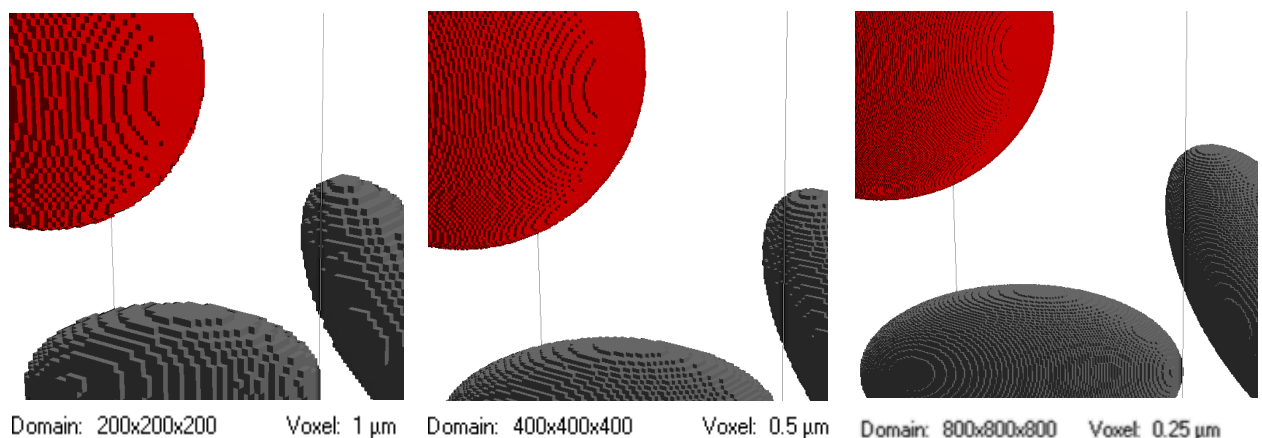

Transforming and modifying 3D structure models

Observe the possibilities of rescaling by starting again with the original structure (200x200x200) and performing several operations.

First, check **Grow Strictly** (instead of Grow Rounded), and enter the **Grow Factor** 3. Click **OK** and **Rescale**. The voxel count in the domain triples to 600x600x600 and the voxel size is one-third, reduced to 0.33 μm . The GAD data is discarded.

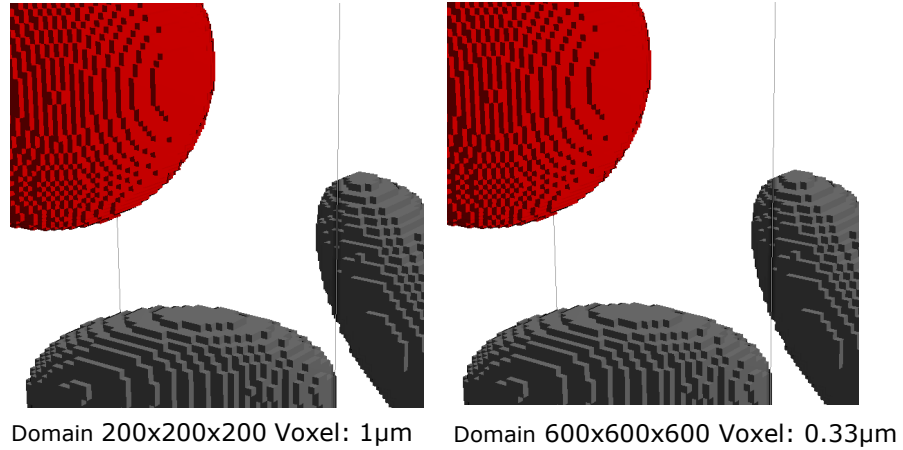

Reload the original structure, check **Shrink**, Click **OK** and **Rescale**. The shrink factor is always 2. The domain is halved to 100x100x100 and the voxel size doubles to 2 μm . The GAD Data is maintained.

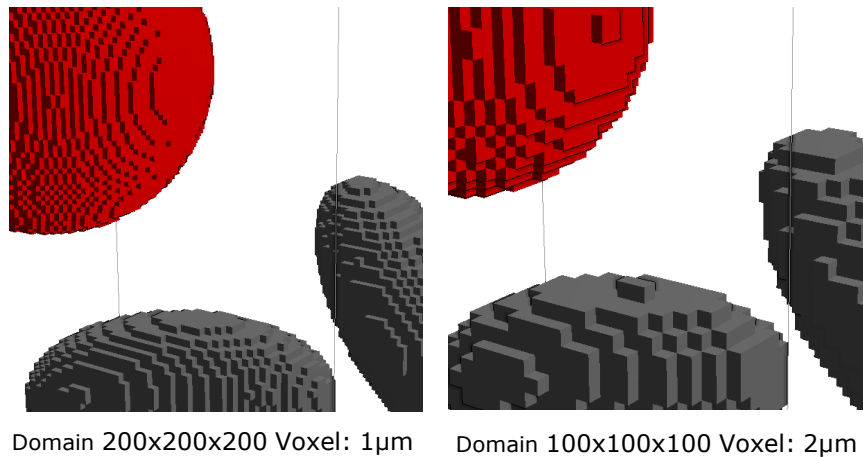

Third, keep **Shrink** checked and click **OK** and **Rescale** to reduce the domain size again (now 50x50x50) and to double the voxel size (to 4 μm). The GAD Data is maintained.

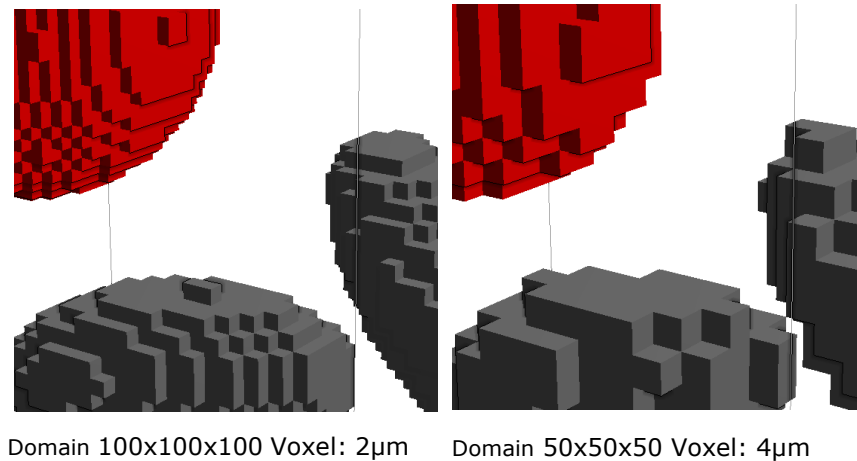

COMPRESS

The operation **Compress** compacts the structure in **Z**-direction by the value entered in **Compression Fraction**. Values must be between 0 and 1, where the extremes (0 [0% compression] and 1 [100% compression]) are not feasible.



For instance, a value of 0.6 (60%) compresses the structure to 40% of its original thickness in **Z**-direction.

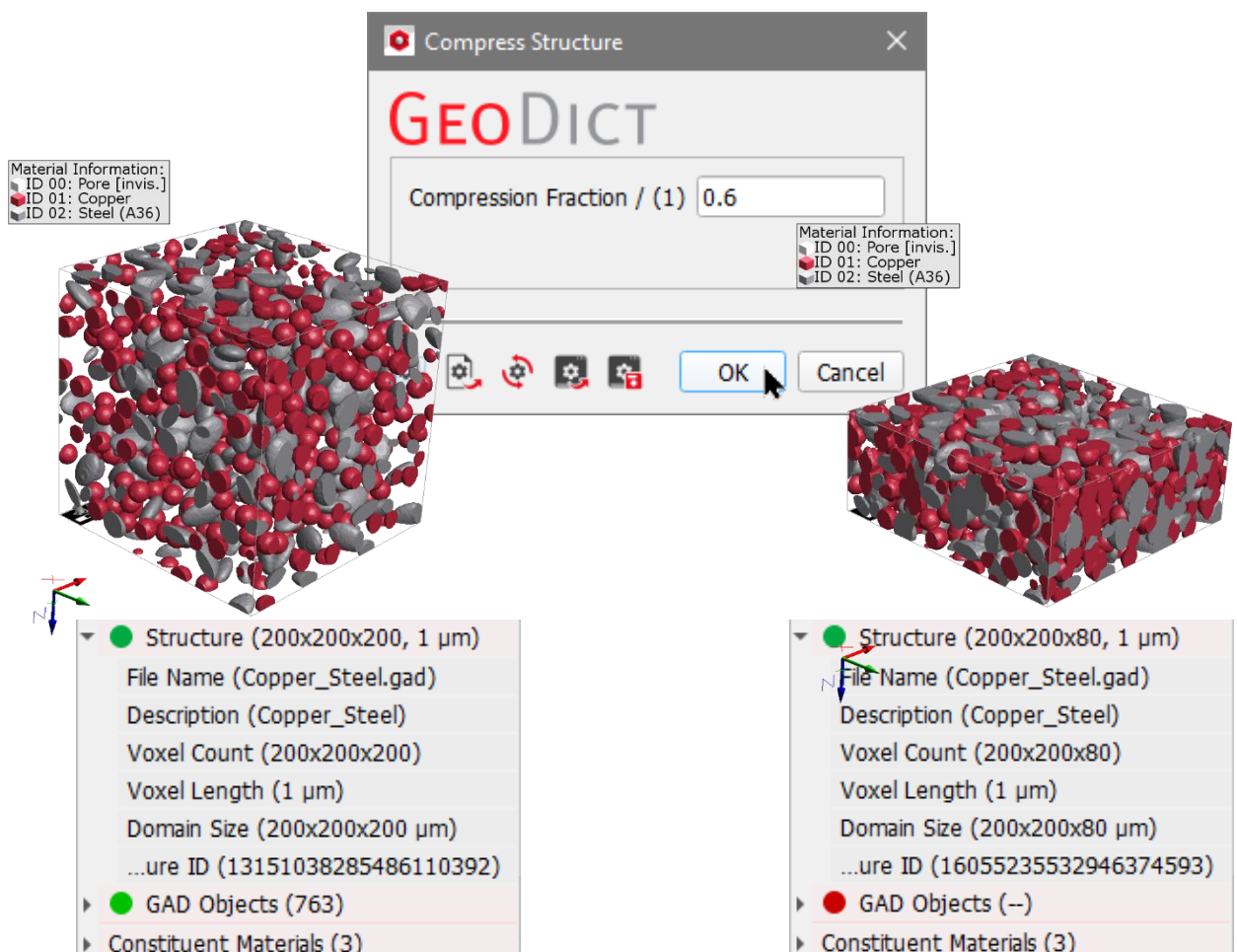

THE ALGORITHM

The compression algorithm is purely geometrical. Each Z pillar is compressed independently. All connected components in the pillar are placed nearer to each other according to the compression fraction. They do not overlap. When only one connected component is left, and the structure should be further compressed the pillar is scaled down and the mass is no longer preserved.

The algorithm is illustrated below: a pillar is "cut out" from the structure, and the two connected components are assigned to different material IDs only for visualization (Reassign). Then, several compression steps are performed: Observe how the solid components move closer to each other while they keep their original size. Once they touch and no empty voxels are left, the component shrinks (see last step).

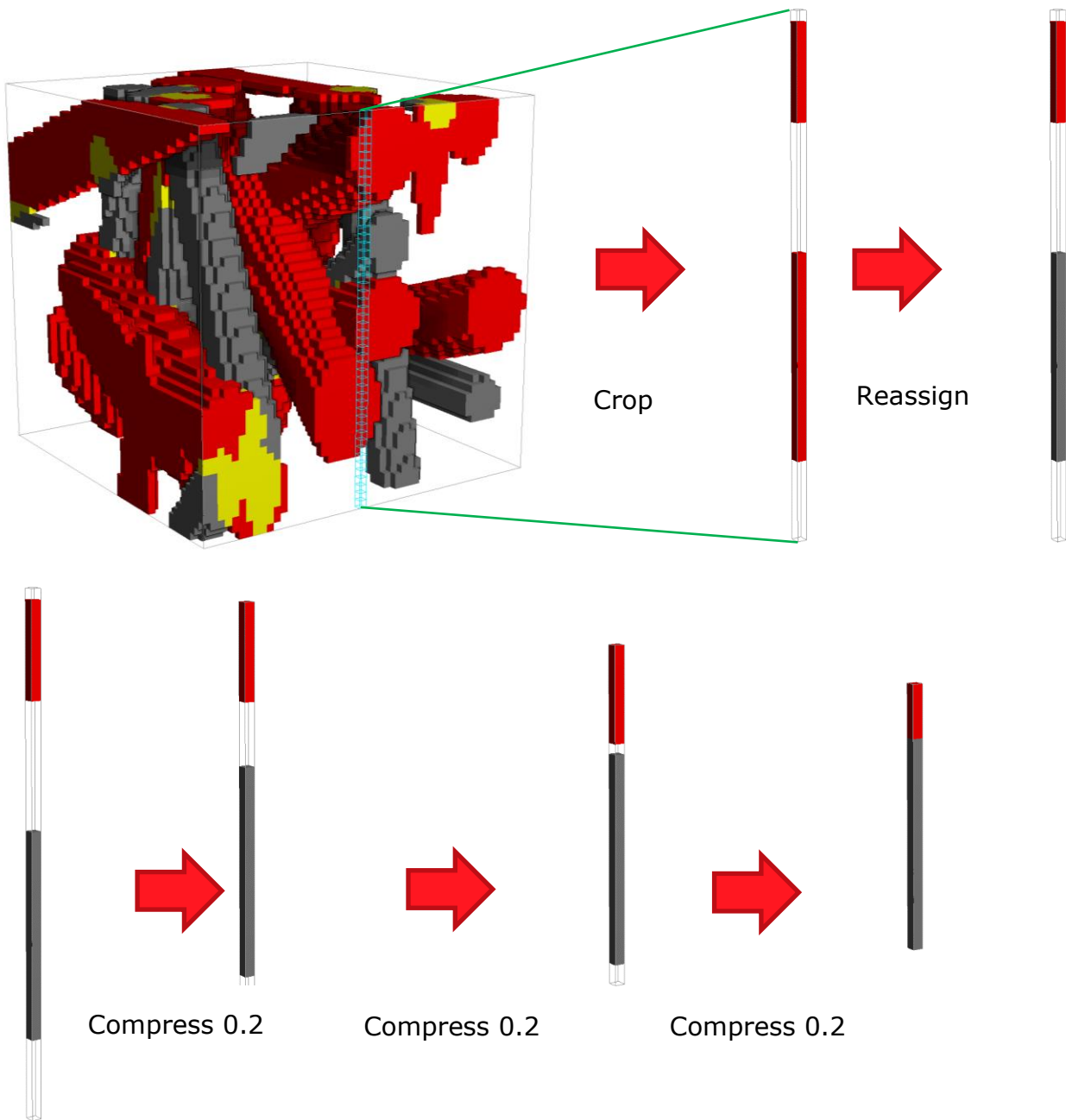

ROTATE 90°, MIRROR, AND PERMUTE

Select **Permute** in the **ProcessGeo** section. After selecting the desired operation in the dialog, change the options for the operation and click **OK**. All operations in **Permute** keep the analytic information of the structure (GAD format).

Then, click **Permute**.

Rotate 90° turns the structure by 90° around the given axis and in the given direction.

Mirror mirrors the whole structure in the selected direction.

Permute changes the allocation of the axis for the current structure.

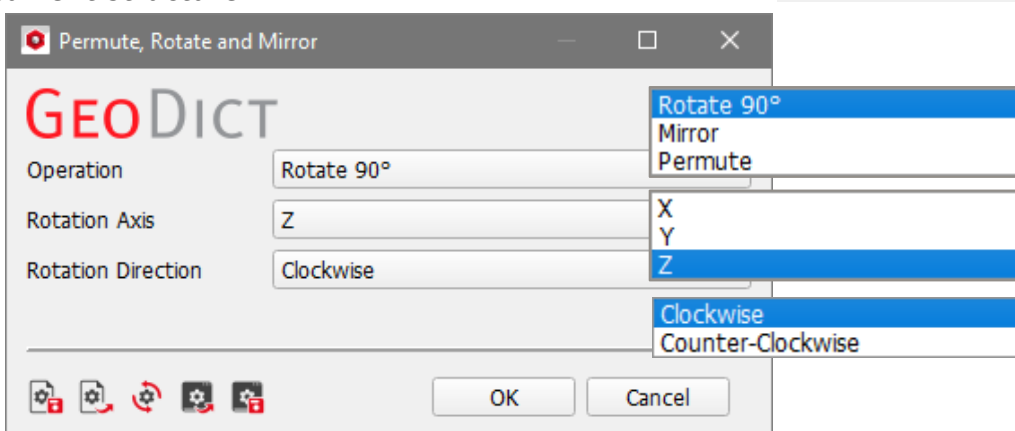
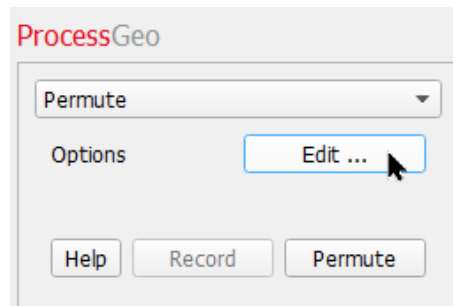

Observe the effect of the following permutations on the position of a structure depicting the casing of a filter. First, the structure is simply rotated clockwise by 90° around the Z-axis. Then, it is mirrored in the long direction (Z-direction).

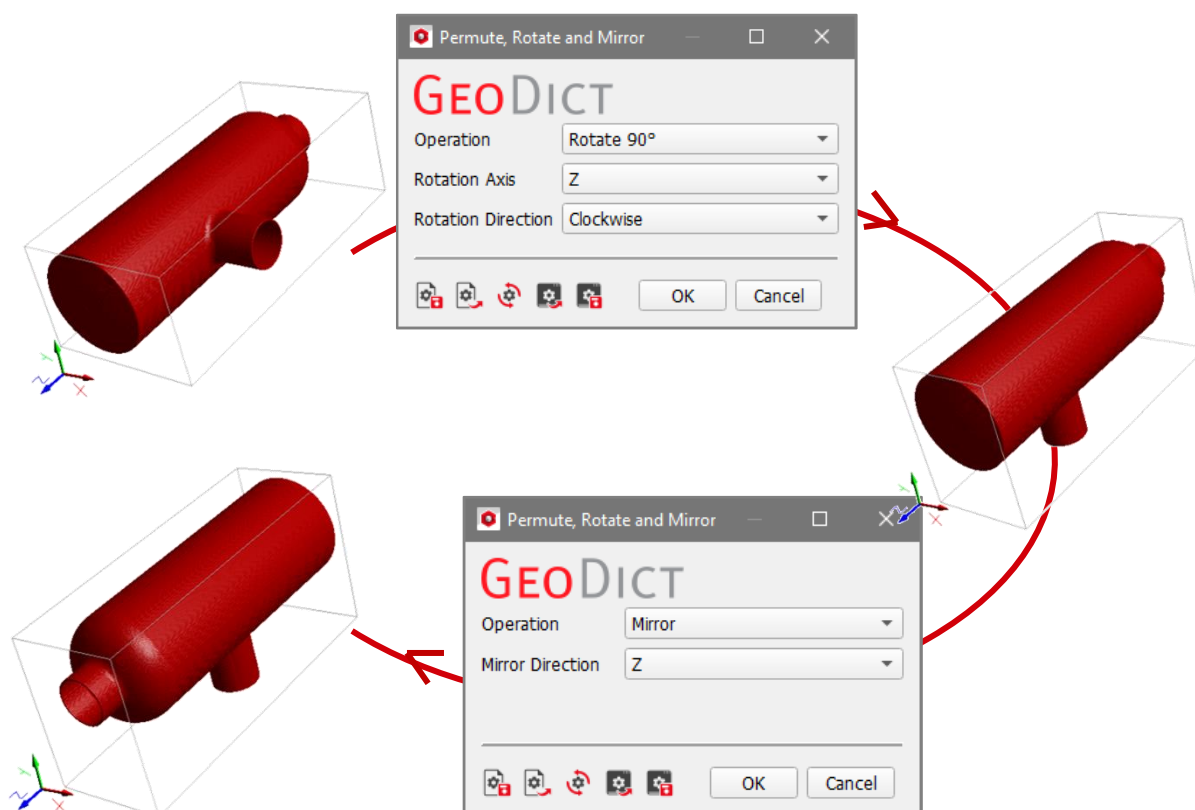

Transforming and modifying 3D structure models

The permutations $X \leftrightarrow Z$, $Y \leftrightarrow Z$ and $X \leftrightarrow Y$ flip or switch the axes. The shape of the domain changes accordingly. In the example below, the side opening of the filter casing that initially opens towards the X-axis, changes to the Y-axis after the permutation.

If the same permutation is applied two times, the original state is achieved again.

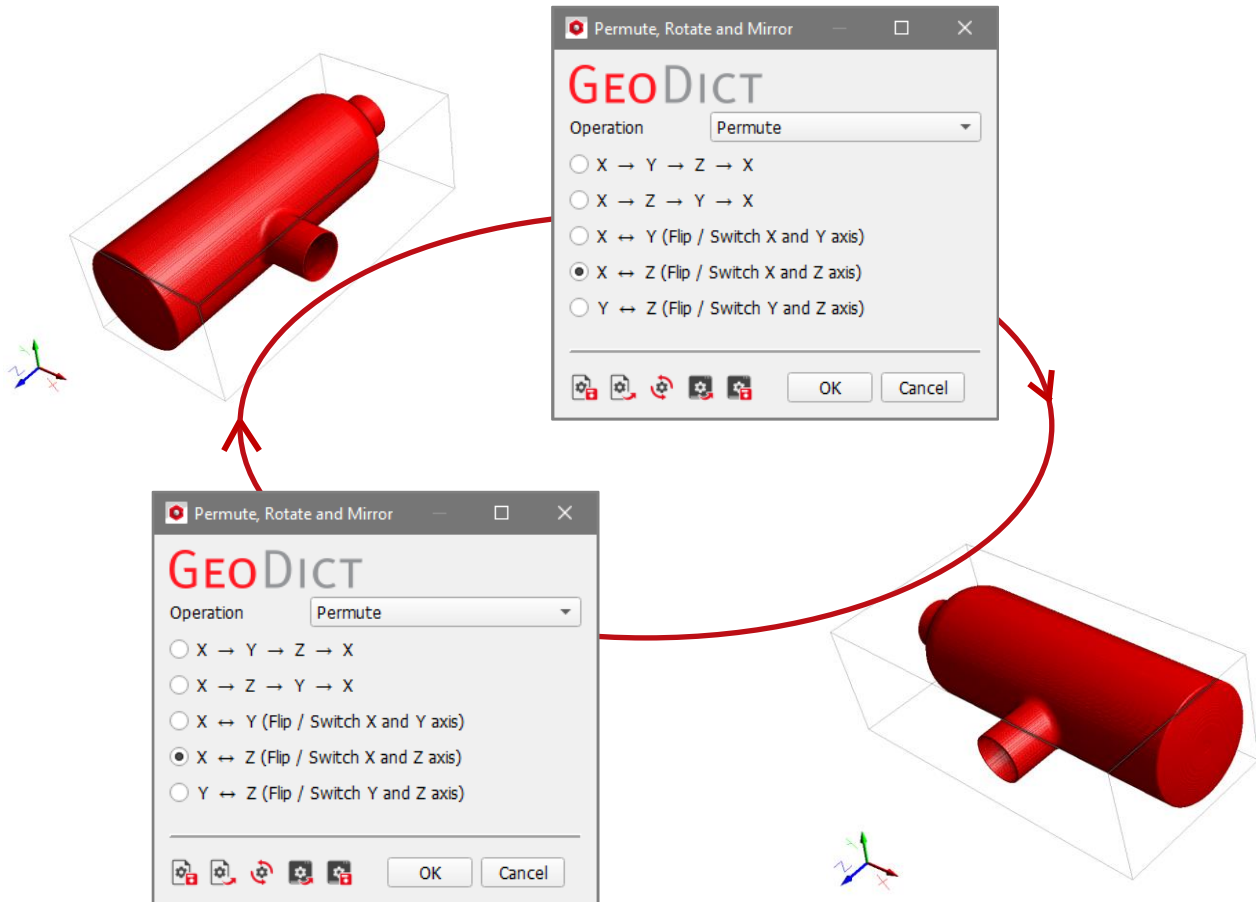

ADD BINDER

Realistic models of nonwoven fibrous structures (for example for the technical textile industry) or of sintered structures (as for binding additives in grain packs, ceramics, and hard-metal sintering processes) can be generated by **Add Binder**. Binder is used to provide structural integrity.

Add Binder to a structure consists of adding material in the shape of a concave meniscus in locations where surfaces in that structure's material are close together.

For hollow fibers, such as Short Hollow, Short Cellulose, Infinite Hollow, Infinite Cellulose, Curved Hollow, and Curved Cellulose, and also for hollow objects, such as hollow spheres, the algorithm under Add Binder needs analytic object data (GAD file) to discern that the empty voxels inside these objects are not part of the pore space. Without analytic data, i.e., when using voxel models, binder is also added inside the hollow objects, which might be inaccurate.

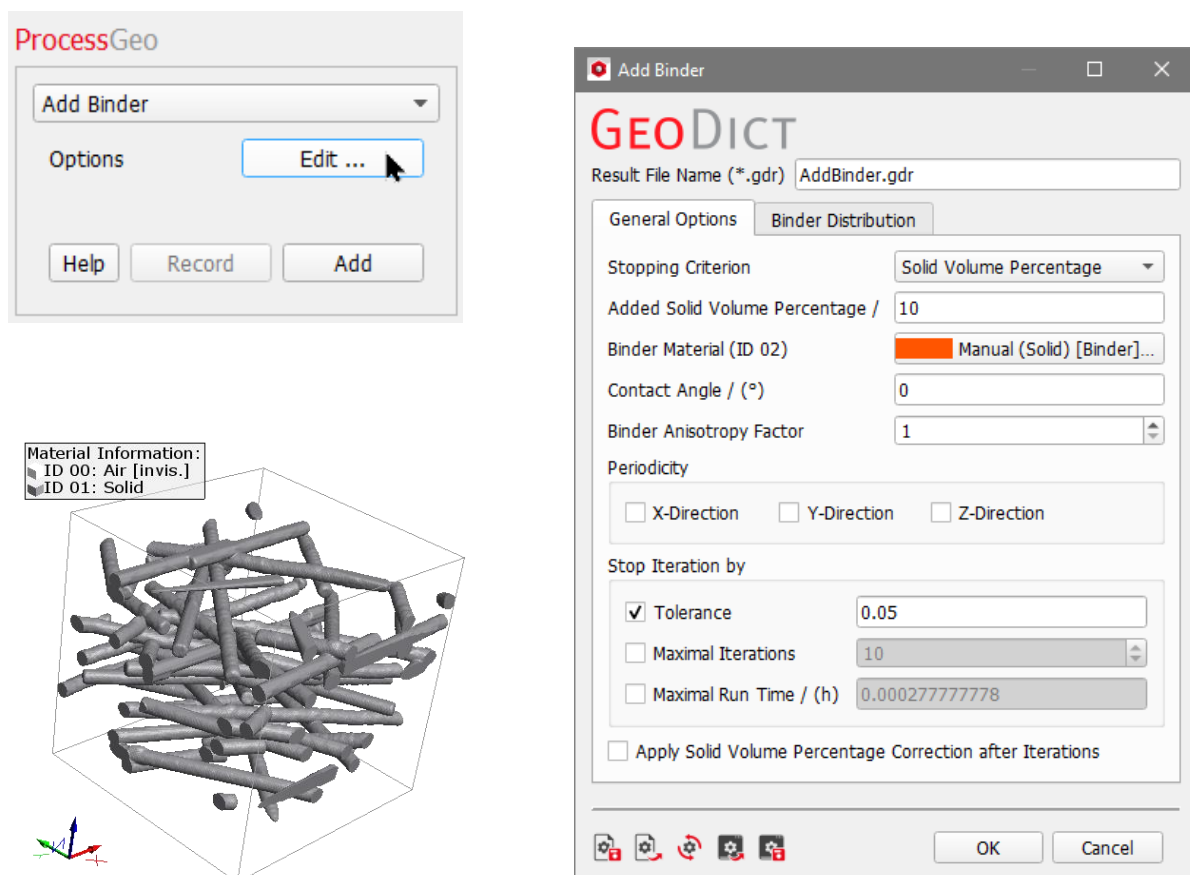

Clicking the **Options' Edit...** button opens the **Add Binder** dialog. Clicking **OK** in it closes the dialog and returns to the **ProcessGeo** section. Clicking **Add** starts the process.

At the top of the **Add Binder** dialog, the name for the file containing the results of adding binding can be entered in the **Result File Name (*.gdr)** box. The default name can be kept, or a new name can be chosen, fitting the current project.

GENERAL OPTIONS

STOPPING CRITERION

The user may choose the most appropriate stopping criterion when adding binder. The chosen **Stopping Criterion** interrupts the addition of binder when it is reached. The available stopping criteria are **Solid Volume Percentage**, **Weight Percentage**, and **Grammage**.

Solid Volume Percentage

The binder volume reaches a pre-established **Added Solid Volume Percentage** (%) relative to the total volume. The added material is displayed as a volume amount deposited on the structure.

The **Binder Material** is assigned to the next available material ID, and the appropriate material to be used as binder should be selected from the material database by clicking the button.

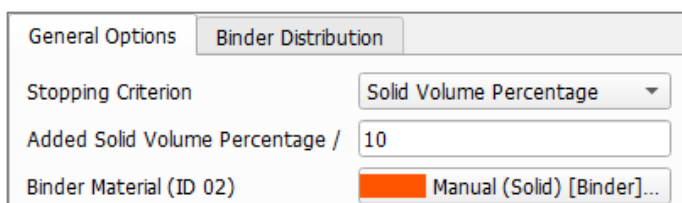

The screenshot shows a dialog box with two tabs: "General Options" and "Binder Distribution". The "Binder Distribution" tab is active. It contains the following fields:

- Stopping Criterion: A dropdown menu set to "Solid Volume Percentage".
- Added Solid Volume Percentage / : A text input field containing the value "10".
- Binder Material (ID 02): A button with an orange square icon and the text "Manual (Solid) [Binder]..."

Weight Percentage

The weight of binder reaches a certain percentage of the weight of material.

As seen above for the Solid Volume Percentage stopping criterion, the **Binder Material** is assigned to the next available material ID, and the appropriate **Binder Material** should be selected from the material database by clicking the button.

It is necessary to set the density for the structure's material (**Material Density**) and for the binder material (**Binder Density**) both in g/cm^3 , as well as the desired (weight) percentage of binder material to structure material (**Binder Weight Percentage**, in %). That is, a **Binder Weight Percentage** of 20 means that there are 20 g of binder added per 80 g of objects in the structure (i.e., 20g per 100g of the resulting structure with binder).

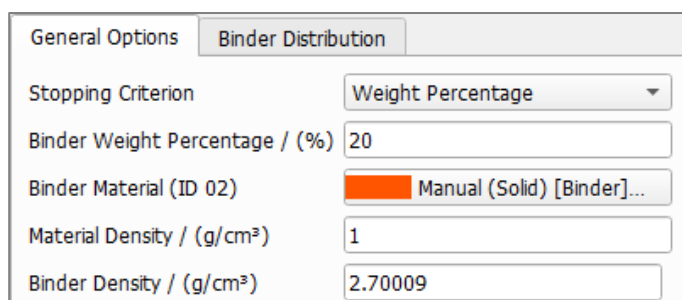

The screenshot shows a dialog box with two tabs: "General Options" and "Binder Distribution". The "Binder Distribution" tab is active. It contains the following fields:

- Stopping Criterion: A dropdown menu set to "Weight Percentage".
- Binder Weight Percentage / (%): A text input field containing the value "20".
- Binder Material (ID 02): A button with an orange square icon and the text "Manual (Solid) [Binder]..."
- Material Density / (g/cm^3): A text input field containing the value "1".
- Binder Density / (g/cm^3): A text input field containing the value "2.70009".

For example, two types of binder (with high density, e.g., Manual 5 g/cm^3 and with lower density, e.g., Polypropylene 0.9 g/cm^3) are added to a fibrous material with a density of 1 g/cm^3 . Setting a **Binder Weight Percentage** of 20% (20 g binder/80 g objects), the amount of binder material deposited is much larger when the binder is less dense.

General Options		Binder Distribution
Stopping Criterion	Weight Percentage	
Binder Weight Percentage / (%)	20	
Binder Material (ID 02)	Manual (Solid) [Binder]...	
Material Density / (g/cm ³)	1	
Binder Density / (g/cm ³)	5	

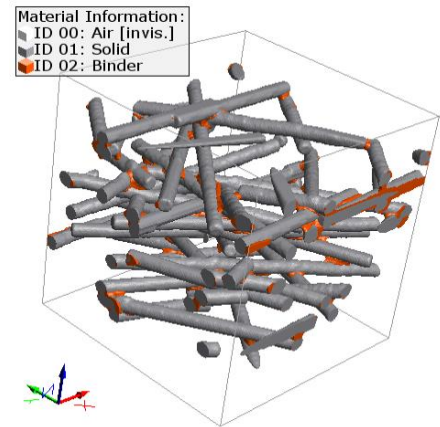

General Options		Binder Distribution
Stopping Criterion	Weight Percentage	
Binder Weight Percentage / (%)	20	
Binder Material (ID 02)	Polypropylene (Solid) [Binder]...	
Material Density / (g/cm ³)	1	
Binder Density / (g/cm ³)	0.9	

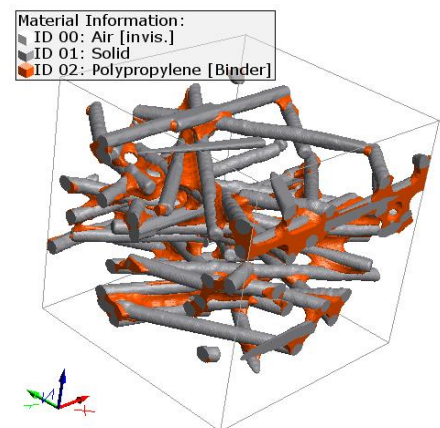

For Weight Percentage, when **Manual** or **Undefined** are selected, the user must enter the density of the binder (**Binder Density / (g/cm³)**). If a material is selected from the database, the **Binder Density** (in g/cm³) of the binder material is automatically entered. If a manual material is used frequently, it is useful to save it to the material database.

Grammage

The addition of binder stops when the **Added Grammage** (g/m²) is reached.

As seen above for the Solid Volume Percentage stopping criterion, the **Binder Material** is assigned to the next available material ID and the appropriate material to be used as binder should be selected from the material database by clicking the button.

General Options		Binder Distribution
Stopping Criterion	Grammage	
Added Grammage / (g/m ²)	10	
Binder Material (ID 02)	Manual (Solid) [Binder]...	
Binder Density / (g/cm ³)	2.7	

For **Grammage**, when **Manual** or **Undefined** are selected, the density of the binder is not automatically taken from the database and the user must enter it manually (**Binder Density [g/cm³]**). If a manual material is used frequently, it is useful to save it to the material database.

Transforming and modifying 3D structure models

CONTACT ANGLE

The **Contact Angle** defines the angle in which the binder is deposited in relation to the materials in the structure.

Values between 0° and 60° are accepted. The contact angle helps to optimize and realistically model the addition of binder.

Observe the effect of adding binder with a **Contact Angle** of 0° or 45°.

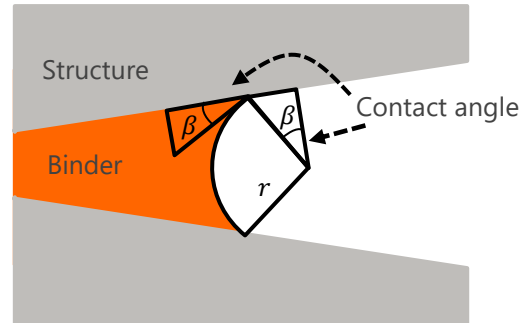

Stopping Criterion	Solid Volume Percentage
Added Solid Volume Percentage / (%)	5
Binder Material (ID 02)	Manual (Solid) ...
Contact Angle / (°)	0
Binder Anisotropy Factor	1

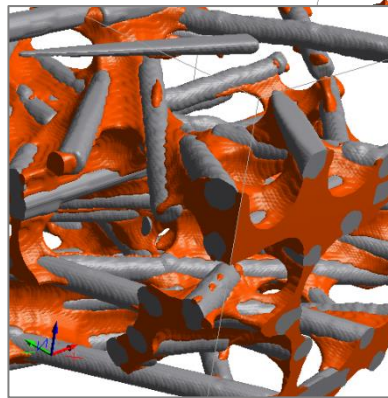
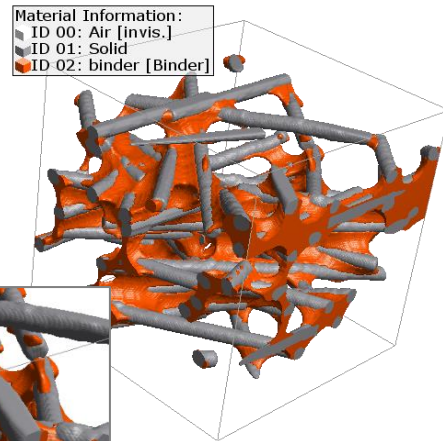

Stopping Criterion	Solid Volume Percentage
Added Solid Volume Percentage / (%)	5
Binder Material (ID 02)	Manual (Solid) ...
Contact Angle / (°)	45
Binder Anisotropy Factor	1

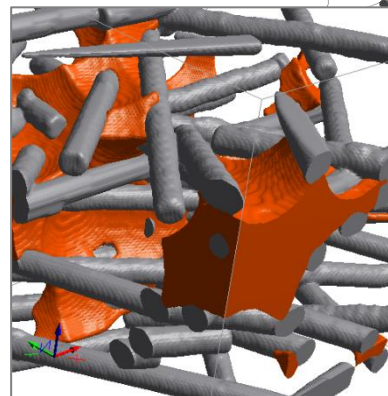
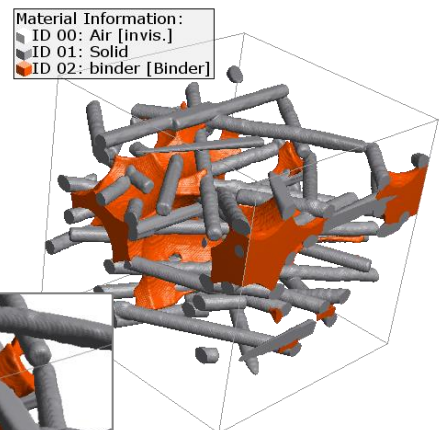

BINDER ANISOTROPY FACTOR

The **Binder Anisotropy Factor** allows to control the grade of binder anisotropy in the X-Y-plane. If the factor is the default value of 1, the binder is distributed isotropically. By choosing larger values, the binder is more distributed in the X-Y-plane but then, the contact angle value is not accurate anymore.

Observe the effect of changing the **Binder Anisotropy Factor** from (the default) 1 to 3 when adding binder.

Stopping Criterion	Solid Volume Percentage ▾
Added Solid Volume Percentage / (%)	5
Binder Material (ID 02)	Manual (Solid) ...
Contact Angle / (°)	0
Binder Anisotropy Factor	1

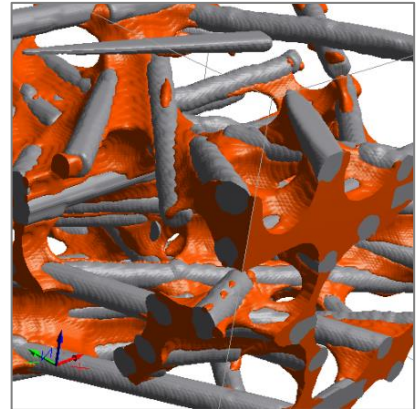

Stopping Criterion	Solid Volume Percentage ▾
Added Solid Volume Percentage / (%)	5
Binder Material (ID 02)	Manual (Solid) ...
Contact Angle / (°)	0
Binder Anisotropy Factor	3

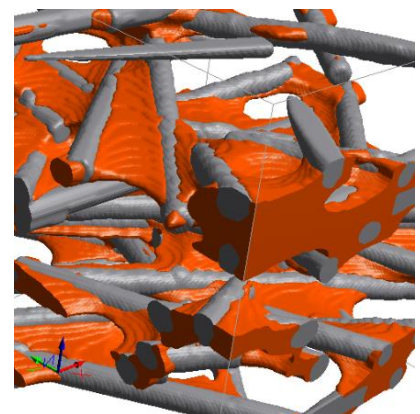

PERIODICITY

The binder might be added periodically in all directions or in a selected direction if the user sets the periodicity in those directions by checking the check boxes in one or more directions (**X-Direction**, **Y-Direction**, and/or **Z-Direction**). Adding binder periodically in certain direction(s) only makes sense if the 3D-structure model is periodic in that/those direction(s).

STOP ITERATION BY

ProcessGeo adds binder through an iterative process, which is repeated until the stopping criterion is fulfilled.

Stop Iteration by	
<input checked="" type="checkbox"/> Tolerance	0.05
<input type="checkbox"/> Maximal Iterations	10
<input type="checkbox"/> Maximal Run Time / (h)	0.000277777778
<input checked="" type="checkbox"/> Apply Solid Volume Percentage Correction after Iterations	

Transforming and modifying 3D structure models

The stopping of the iterative process is controlled by checking and setting values for **Tolerance**, **Maximal Iterations**, or **Maximal Run Time (h)**.

Tolerance is the allowable amount of absolute variation between the entered target value for the selected stopping criterion (Solid Volume Percentage, Weight Percentage, or Grammage) and the value reached by the algorithm.

The user may also choose to have the addition of binder stop by a certain number of **Maximal Iterations** or **Maximal Run Time (h)**.

Information on the stopping of the algorithm and the number of iterations can be found in the Result Viewer of the *.gdr result file.

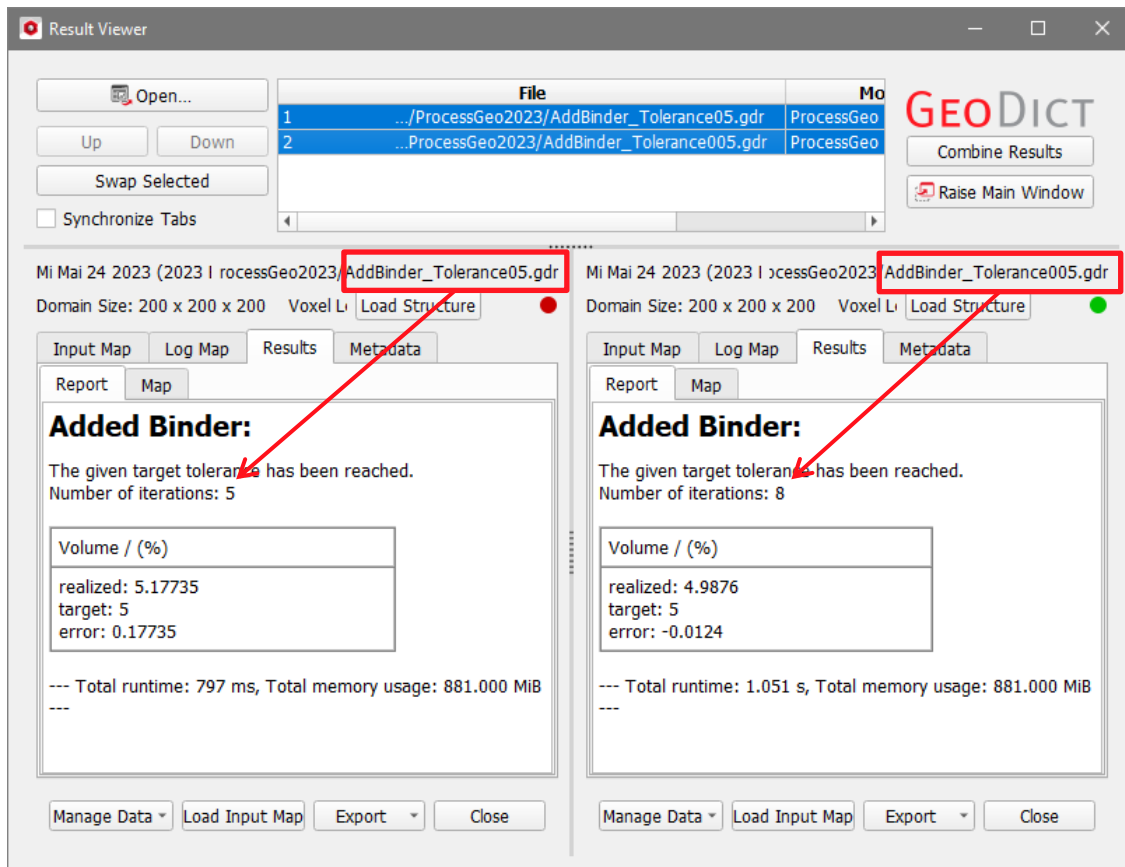

If **Apply Solid Volume Percentage Correction after Iterations** is checked, an additional step is done after the previously defined stopping criterion in **Stop Iteration by** is reached. In this step the amount of binder is optimized to better fit to the given **Added Solid Volume Percentage**. But this may lower the accuracy of the chosen **Contact Angle**.

This option is also available if the binder stopping criterion is chosen as **Weight Percentage** or **Grammage** and then a **Weight Percentage Correction** or a **Grammage Correction** is done, respectively.

BINDER DISTRIBUTION

In real life, the process of adding binder to the material is affected by gravity and the viscosity of the binder, leading to inhomogeneous distributions. This effect can be modeled by defining a distribution of the binder under the **Binder Distribution** tab.

The default distribution is **Homogenous**, but it can be changed to a **Density Distribution in Z-Direction** to allow the modeling of inhomogeneity.

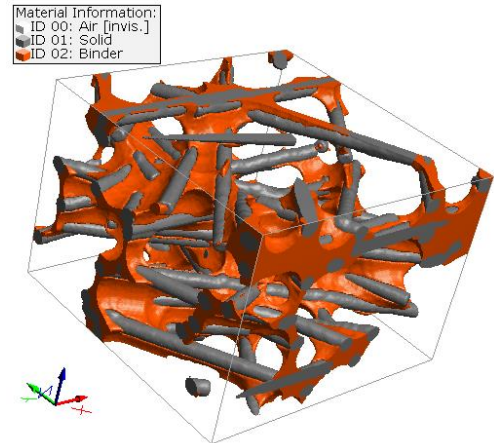
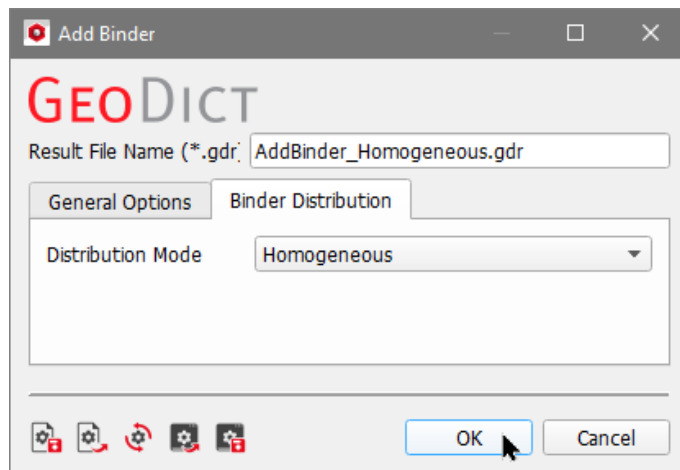

To model a **Density Distribution in Z-Direction**, we remove the inlet from the example by cropping it as shown in page 3. This is necessary because the algorithm strives to reach the desired binder amount for each sub-segment and will try to add binder in the empty domain. Alternatively, the amount of binder might be set to zero for these segments.

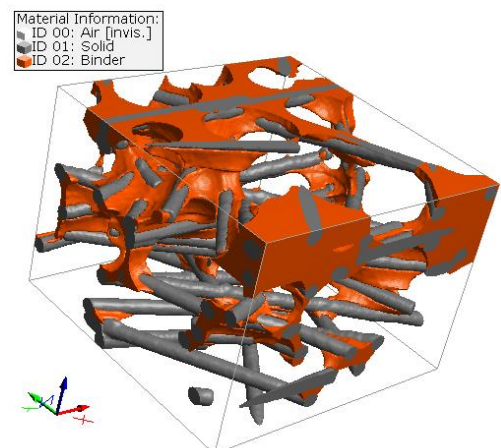
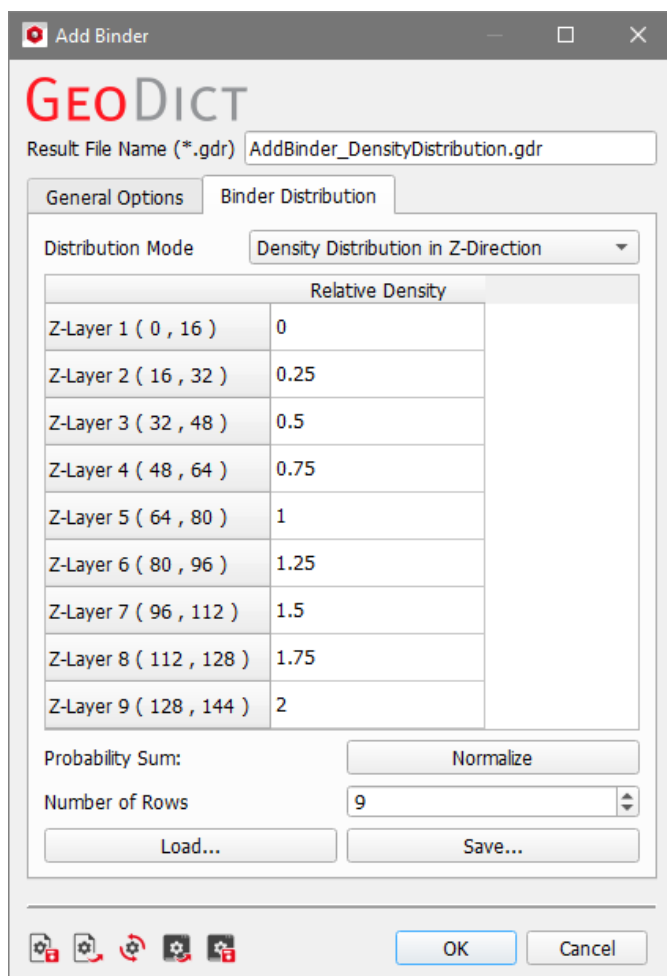

Enter the **Number of Rows** to define the number of Z-segments. To change the number of segments, change the **Number of Rows** to the number of segments desired.

In each segment, the binder is generated separately according to the parameters defined under the **General Options** tab. The **Added Solid Volume Percentage / (%)** is scaled with the normalized **Relative Density** given in the table of **Binder Distribution**.

Transforming and modifying 3D structure models

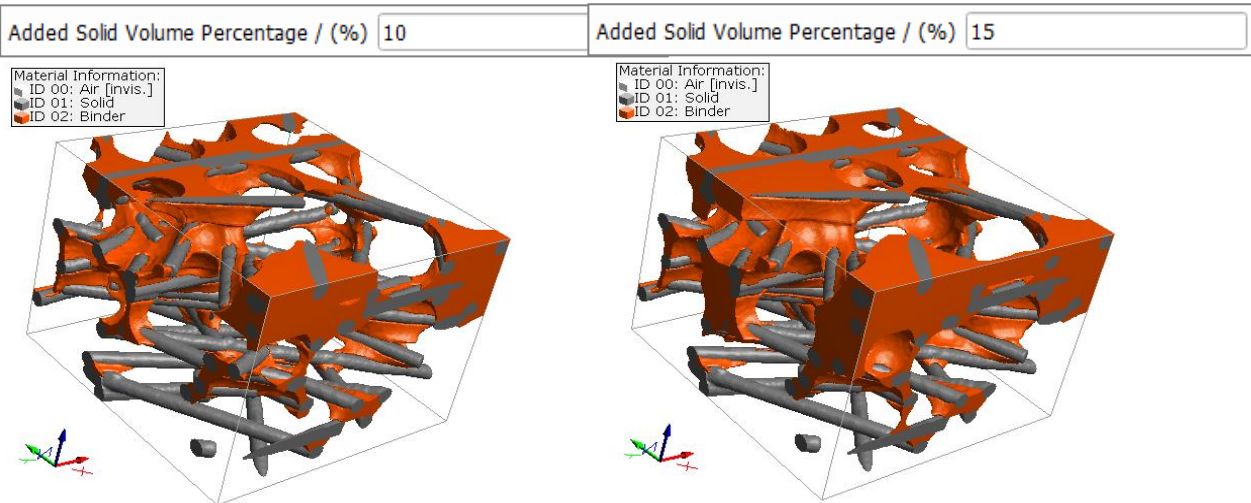

The **Binder Distribution** can be entered in form of a ratio in the **Relative Density** table.

In the images below, three different segments are clearly discernible with a binder distribution according to the relative values given in the table.

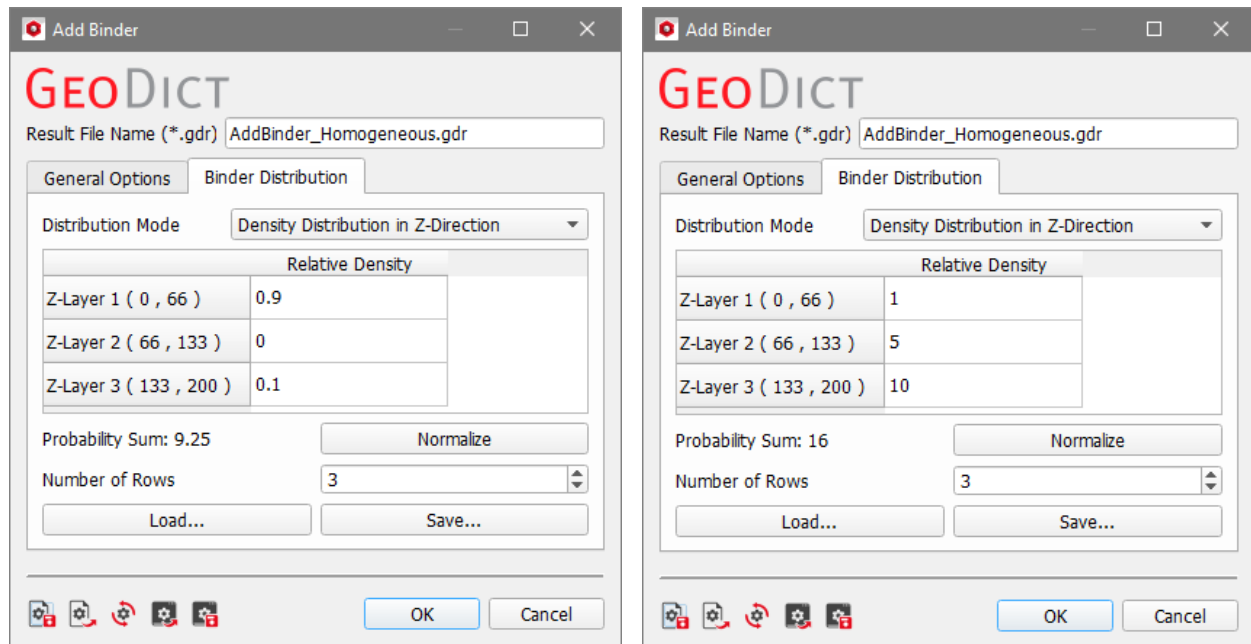

Material Information:
 ID 00: Air [Invis.]
 ID 01: Solid
 ID 02: Binder



Material Information:
 ID 00: Air [Invis.]
 ID 01: Solid
 ID 02: Binder

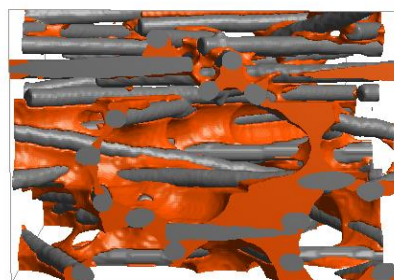

Clicking the **Normalize** button ensures the Relative Density values sum up to one.

With the Buttons **Load...** and **Save...** the Distribution can be loaded/saved as text file which can be opened with other software as e.g. Microsoft Excel.

The parameters entered in the **Add Binder** dialog can be saved into *.gps (GeoDict Project Settings) files and/or loaded from them. Remember to restore and reset your (or GeoDict's) default values through the icons at the bottom of the dialog when needed and/or before every ProcessGeo-Add Binder run. Resting the mouse pointer over an icon shows a tooltip explaining the icon's function.



INVERT

Select **Invert** from the pull-down menu to switch easily solid voxels to pores and pores to solid voxels. **Invert** interchanges background and structure voxels. Use this feature when treating images where background and structure values are permuted, e.g. some types of tomographic images.

With the structure to invert displayed in the Visualization area (in memory), click **Invert**.

Be aware that the analytic object information is lost by inverting because all materials are mapped to void space in this case.

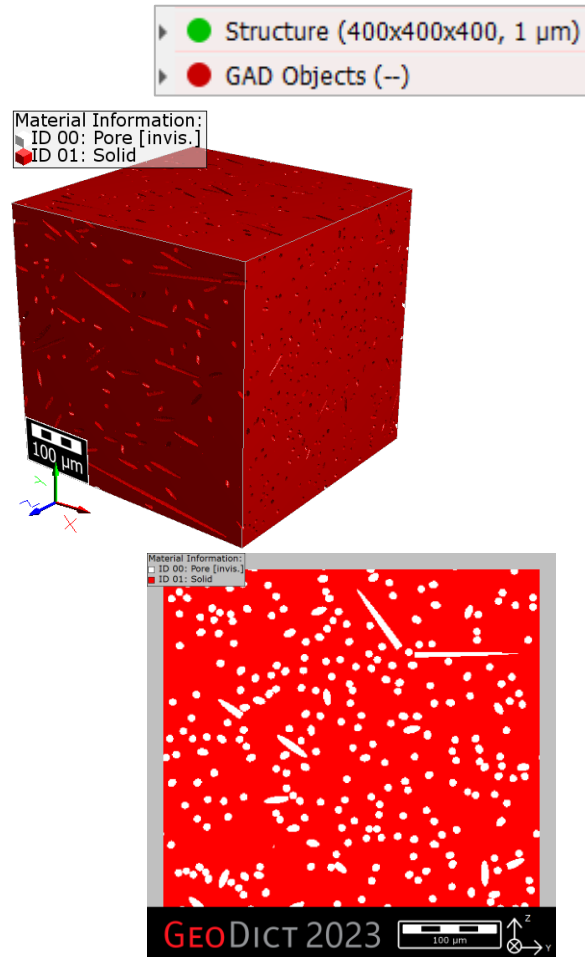
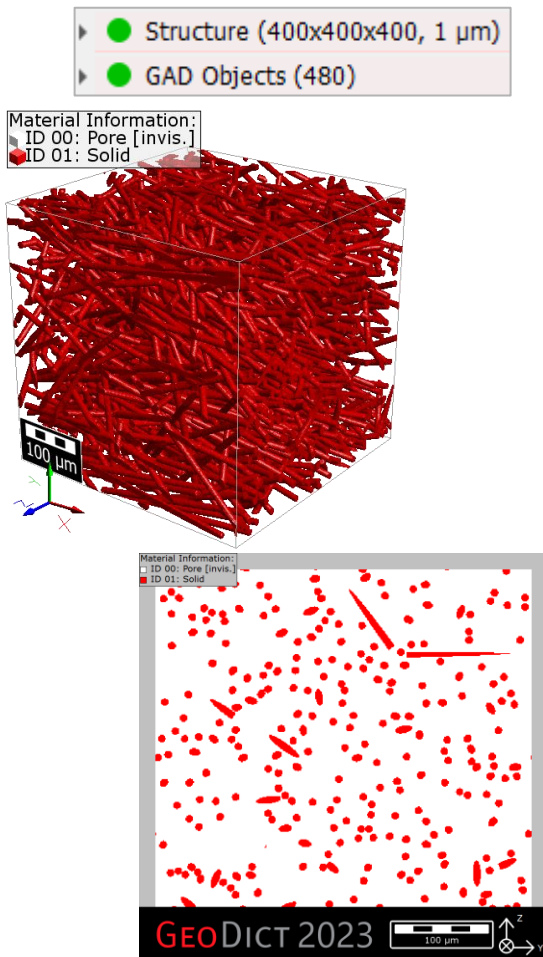
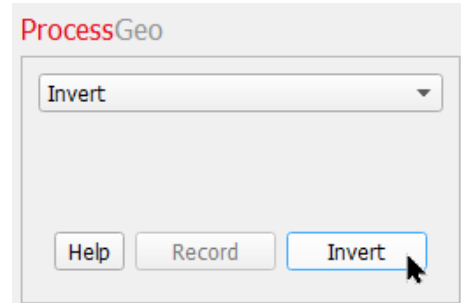

CREATE EMPTY GEOMETRY

An empty domain can be generated by choosing **Create Empty Geometry** and clicking the **Edit...** button.

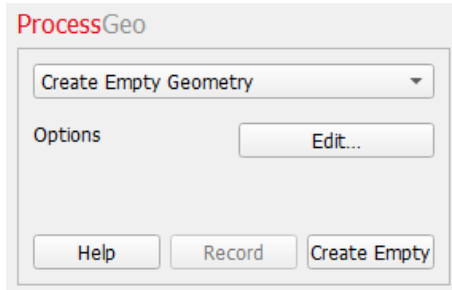

In the **Voxel Geometry Parameters** dialog, the parameters defining size, resolution, origin, and periodicity of the empty geometry are entered.

Also, instead of an empty domain, a material from the Material Database can be assigned to material ID 00. In this way, a block of any given material can be generated.

Clicking **OK** closes the dialog and clicking on **Create Empty** starts the creation.

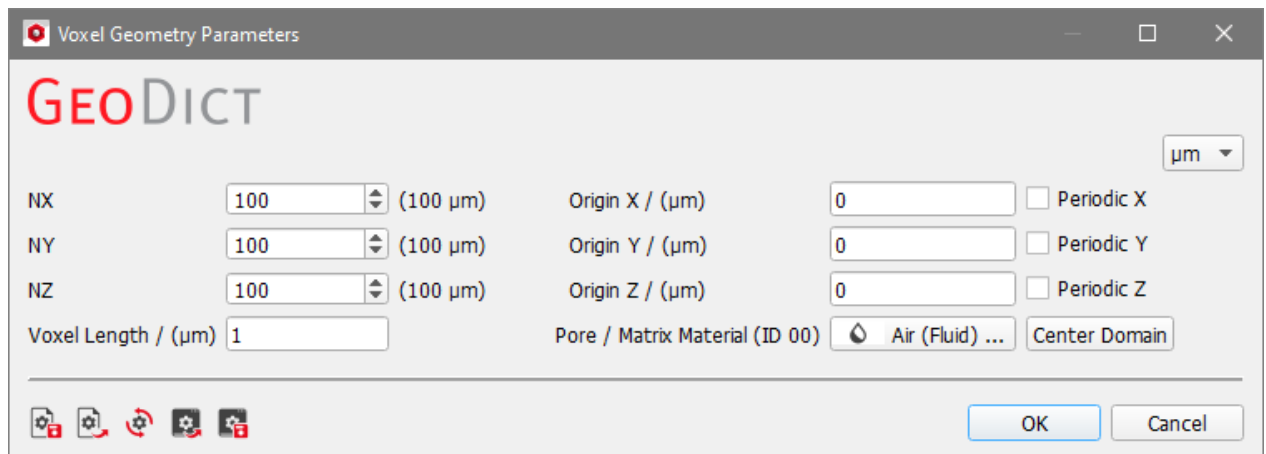

Material Information:
ID 00: Air [invis.]

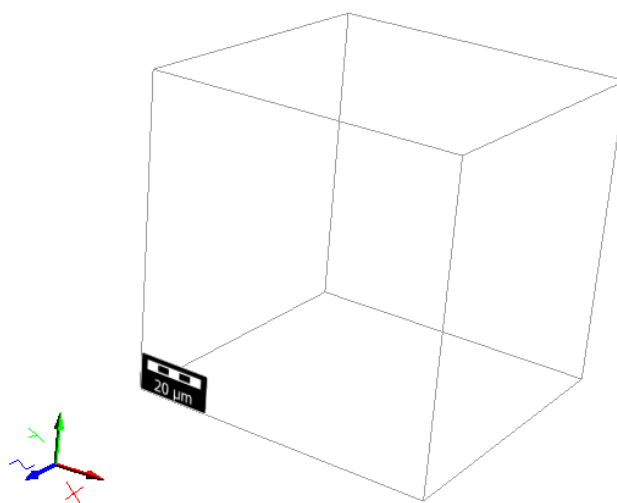

MARK COMPONENTS

Mark Components finds all voxels of a specified Material ID that are connected to each other and to the selected boundary(s). The voxels found to be connected are then reassigned to a new Material ID selected by the user. **Mark Components** can e.g. be used to validate that the structure model has a through-pore in flow direction.

Click the **Options' Edit...** button to open the **Mark Connected Components** dialog.

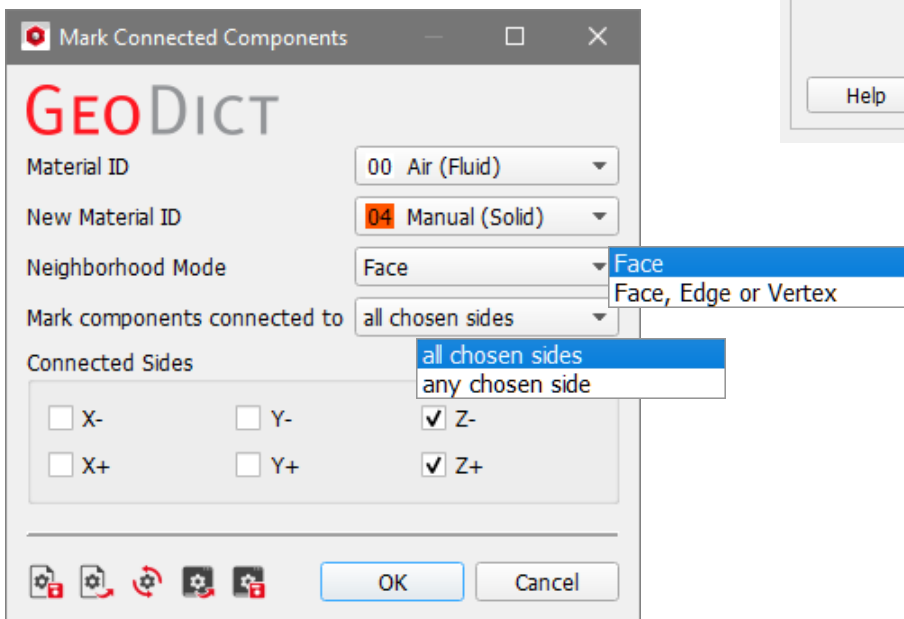
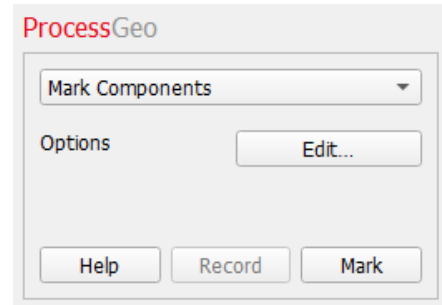

Material ID defines the material for which the connected component analysis should be done.

New Material ID assigns the material to be applied to the connected voxels.

The selections in the **Neighborhood Mode** follow the rules explained in detail in page [17](#).

Mark components connected to defines how the connected sides are interpreted. When set to **all chosen sides**, only those connected components that are touching all boundaries selected in the **Connected Sides** panel are marked.

If **Mark components connected to** is set to **any chosen side**, the connected components only need to touch one of the boundaries chosen in the **Connected Sides** panel to be marked.

The following example uses a model generated with the **GadGeo** module of **GeoDict** to show the effect of several combinations of **Mark components connected to** and **Connected Sides**.

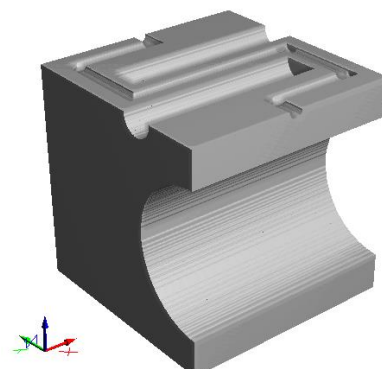

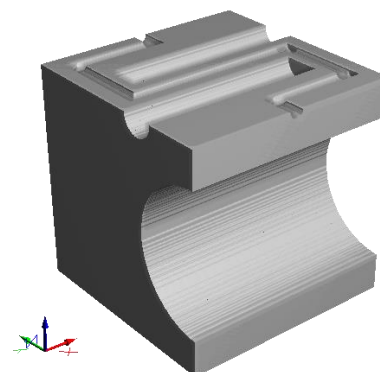
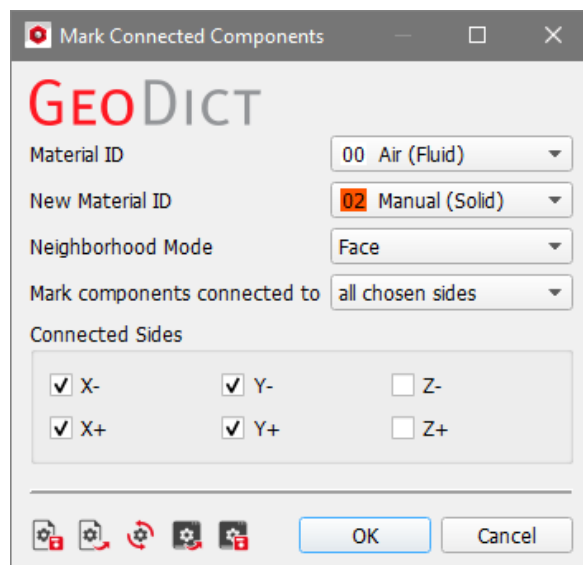
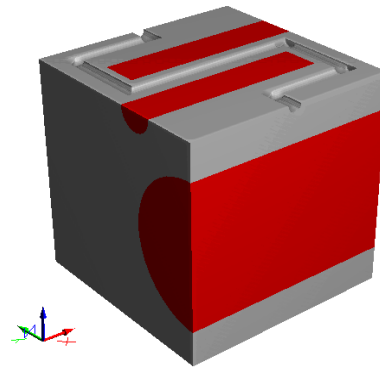
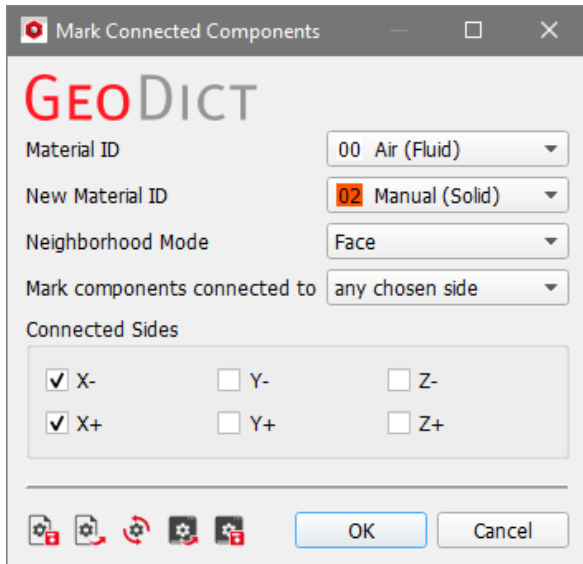
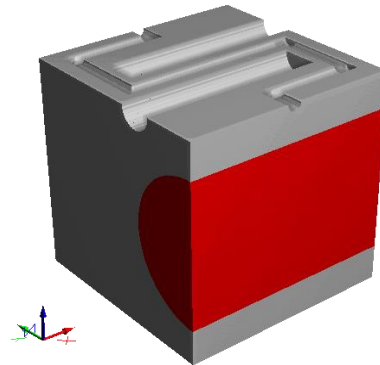
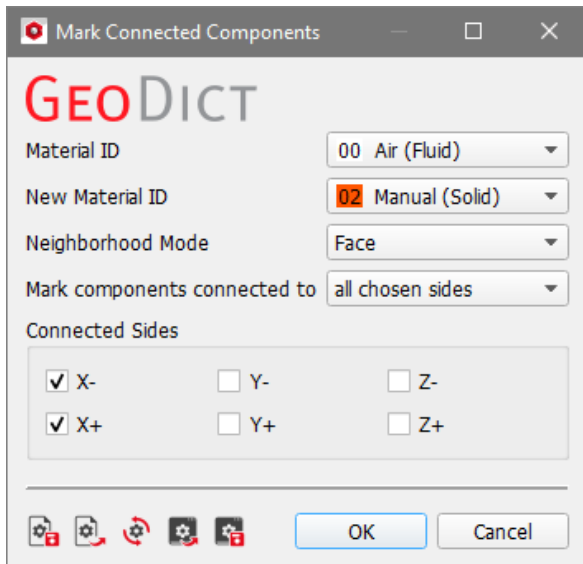

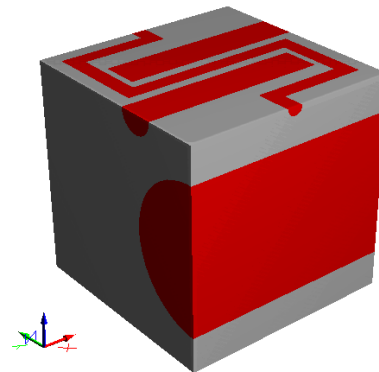
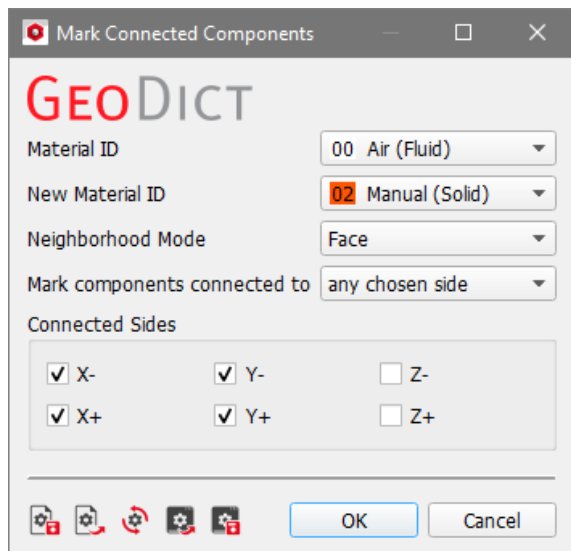

FLOOD-FILL LARGE PORES

In **ProcessGeo**, the Flood-Fill feature allows to separate large and small pores, when at least two scales of pore sizes are present in the microstructure.

In a practical case, it might be used to fill up and separate all the empty pore-space around single grains, which internally have much smaller pores. A single grain, such as (for example) the following, contains small pores:

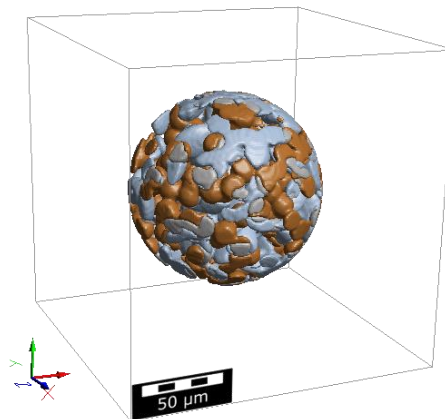

To flood-fill the large pores, click the **Options' Edit...** button to open the **Flood Fill Large Pores** dialog.

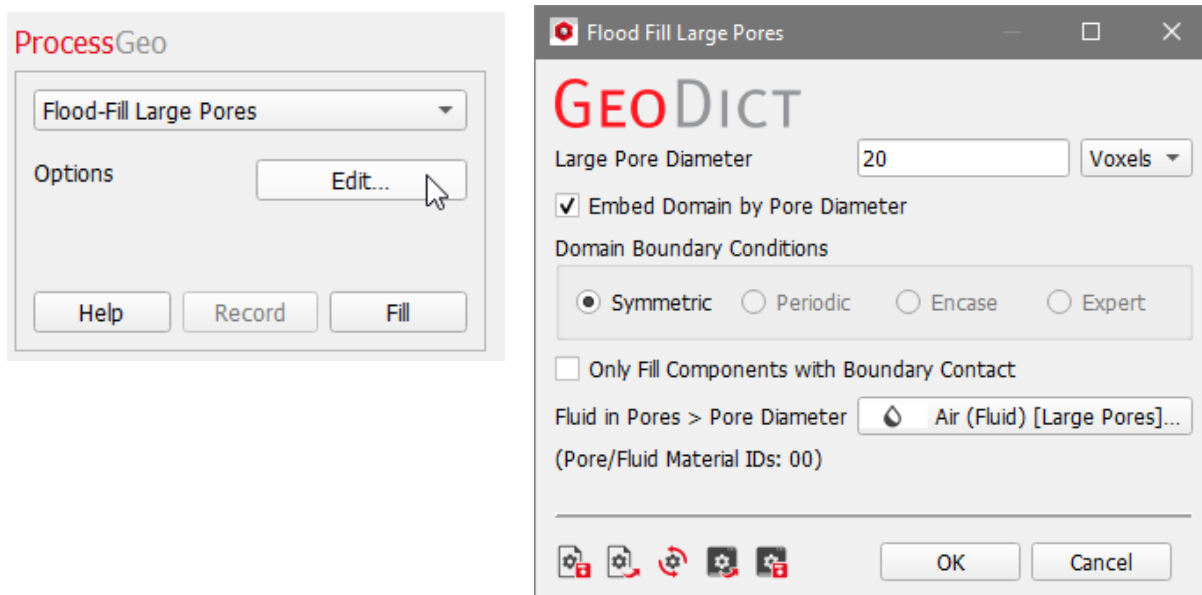

The value entered in **Large Pore Diameter** defines the size for a large pore and excludes smaller pores from being flood-filled. In the following example, the value entered for Large Pore Diameter (20 voxels) is larger than the diameter of the small

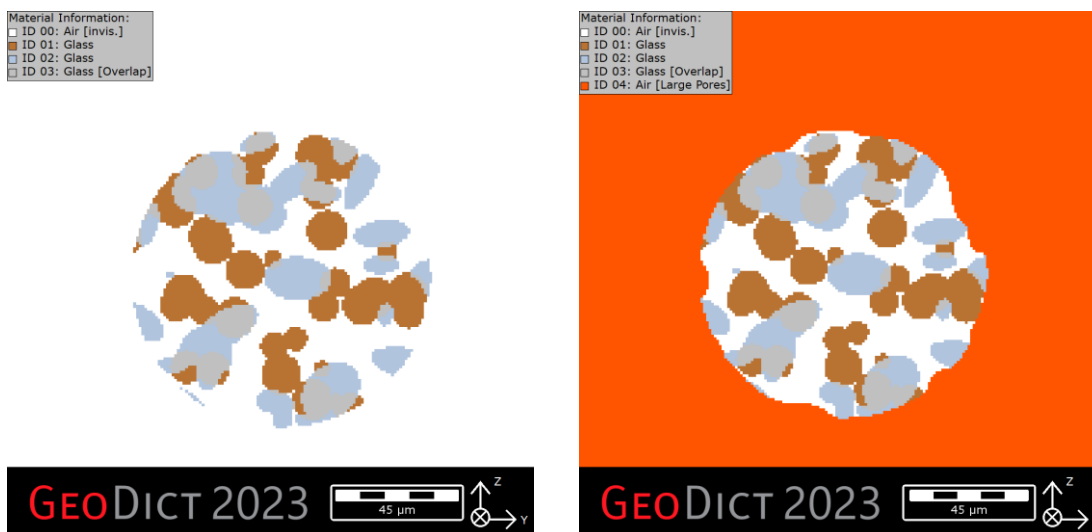

Transforming and modifying 3D structure models

pores inside the grain. As a result, the pore space around the grain is flood-filled and the smaller pores inside the grain remain untouched.

Keeping **Embed Domain by Pore Diameter** checked avoids artifacts at the domain boundary, but slightly increases runtime and memory usage.

A good example to show the effect of different boundary conditions for flood-filling of large pores is a **Catalyst Layer (PEM Fuel Cell)**. This Catalyst Layer is generated with the **Fuel Cell and Electrolyser GeoApp PEM Components Generation**. The large pores inside the microstructure are flood-filled.

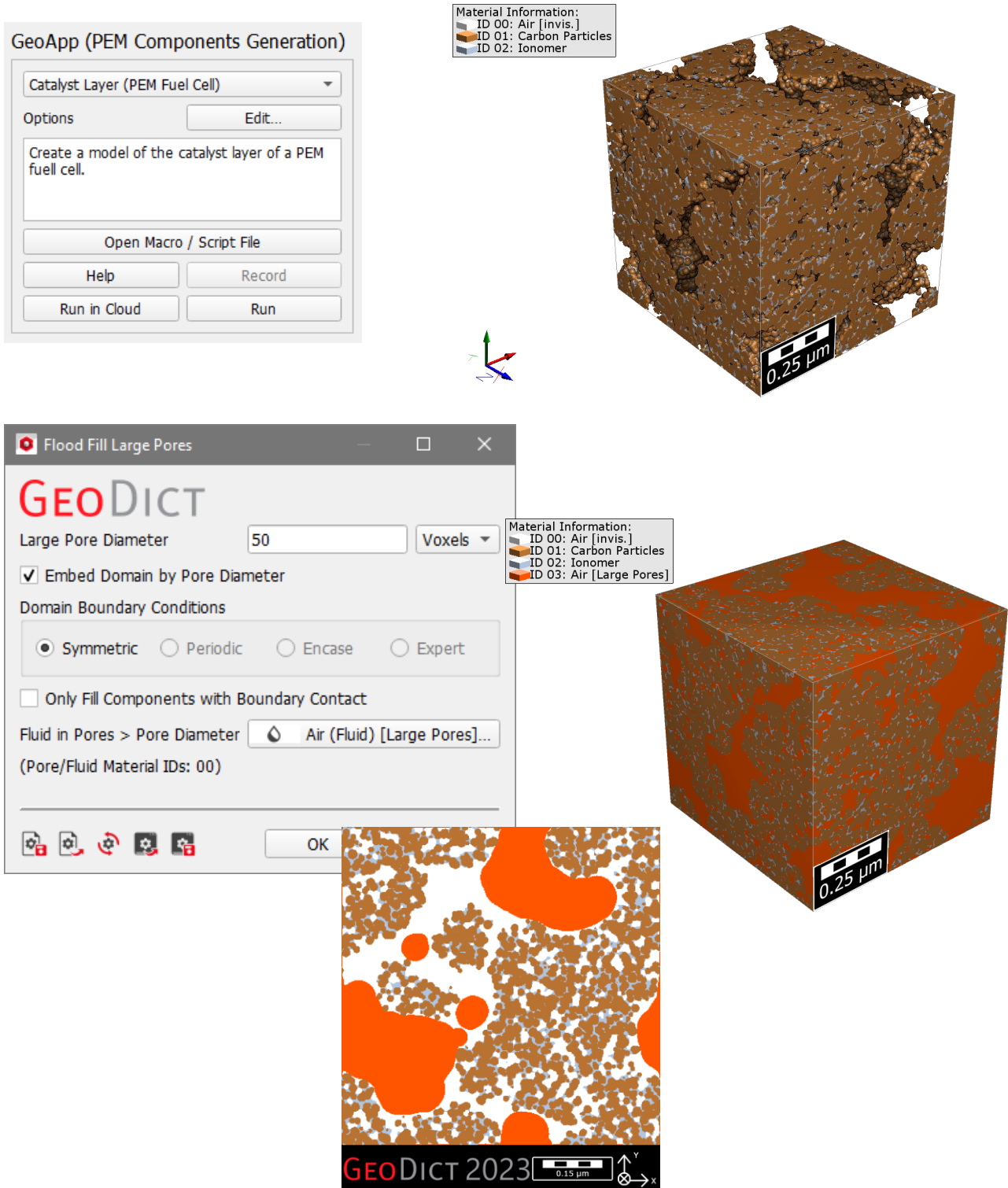

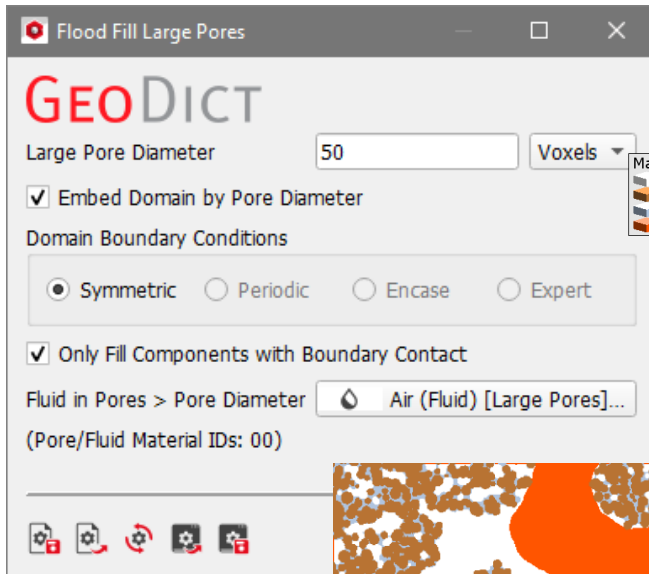

Material Information:
 ID 00: Air [Invis.]
 ID 01: Carbon Particles
 ID 02: Ionomer
 ID 03: Air [Large Pores]

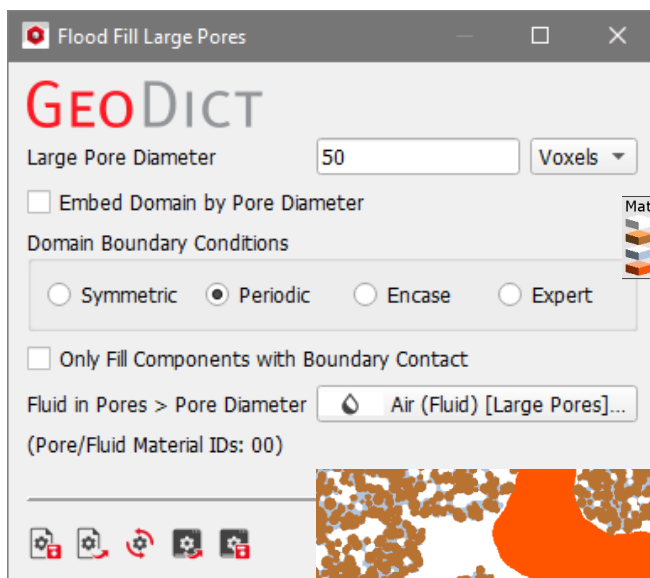
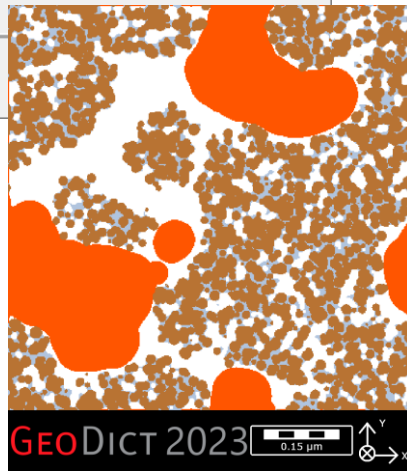
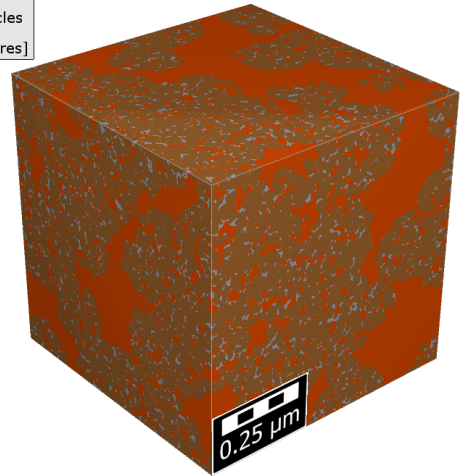

Material Information:
 ID 00: Air [Invis.]
 ID 01: Carbon Particles
 ID 02: Ionomer
 ID 03: Air [Large Pores]

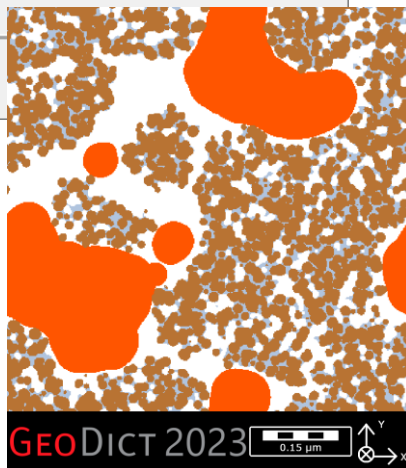
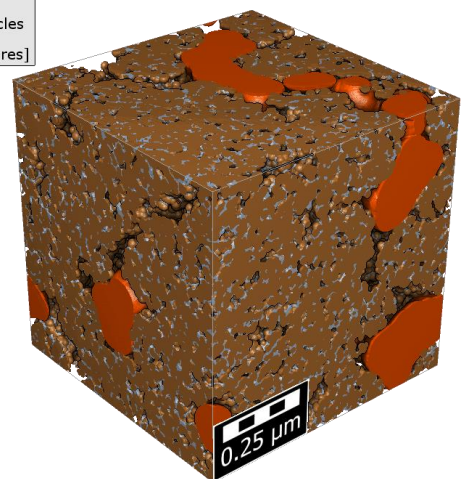

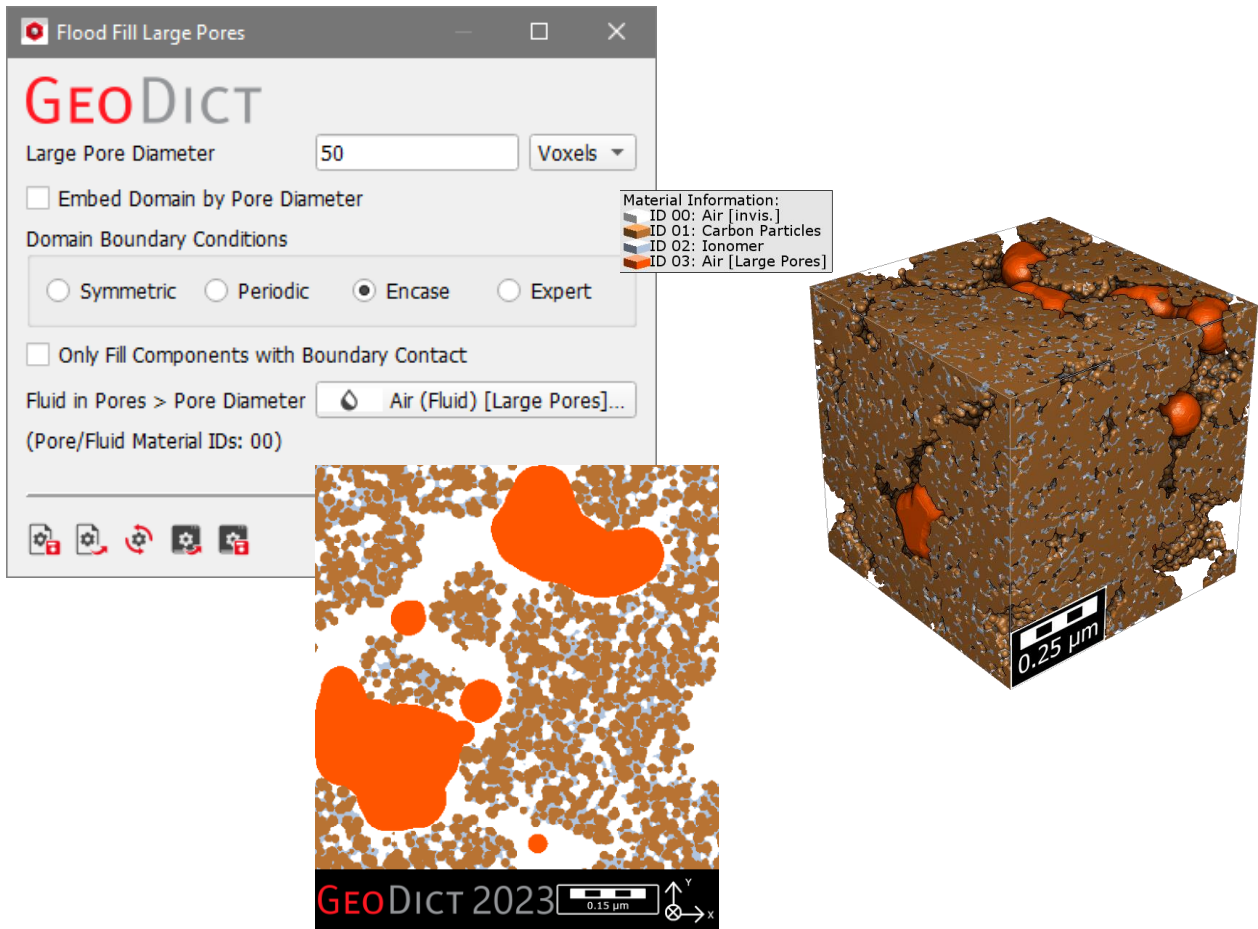

Technical
documentation:

Anne Blumer
Barbara Planas

MATH
2 MARKET

Math2Market GmbH

Richard-Wagner-Str. 1, 67655 Kaiserslautern, Germany
www.geodict.com